

TEM®

2021
Fiyat Listesi

İÇİNDEKİLER

- 2-10 Alüminyum Grup Prizler
- 11-15 Masa Tipi Grup Prizler
- 16-20 Aydınlatma Grubu
- 21-22 Priz Kutuları
- 23-25 Modüler Prizler



- 26 IEC Soketler
- 27 GST Soketler
- 28 Gerilim Koruma (SPD)
- 29-30 Wireless Şarj
- 31-32 Multimedya Soketler
- 33-34 Faceplate - Konnektörler - Kapaklar
- 35 Akım Koruma Cihazları - Anahtarlar
- 36 Bluetooth Hoparlör
- 37 Kablolar
- 38-39 Monofoze Fiş & Prizler
- 40 Trifaze Fiş & Prizler
- 41-51 CEE Norm Fiş & Prizler



- 52-55 Kombinasyon Kutuları
- 56 Taşıyıcı Ayak
- 57 Termoplastik Buatlar
- 58-63 Plastik Panolar
- 64-67 Kablo Makaraları



- 68-72 Acil Aydınlatma
- İzolatörler
- Baladoz
- Bant Armatür Soketleri
- Kablolar
- Kablo Bağı



TEM 1U PDU

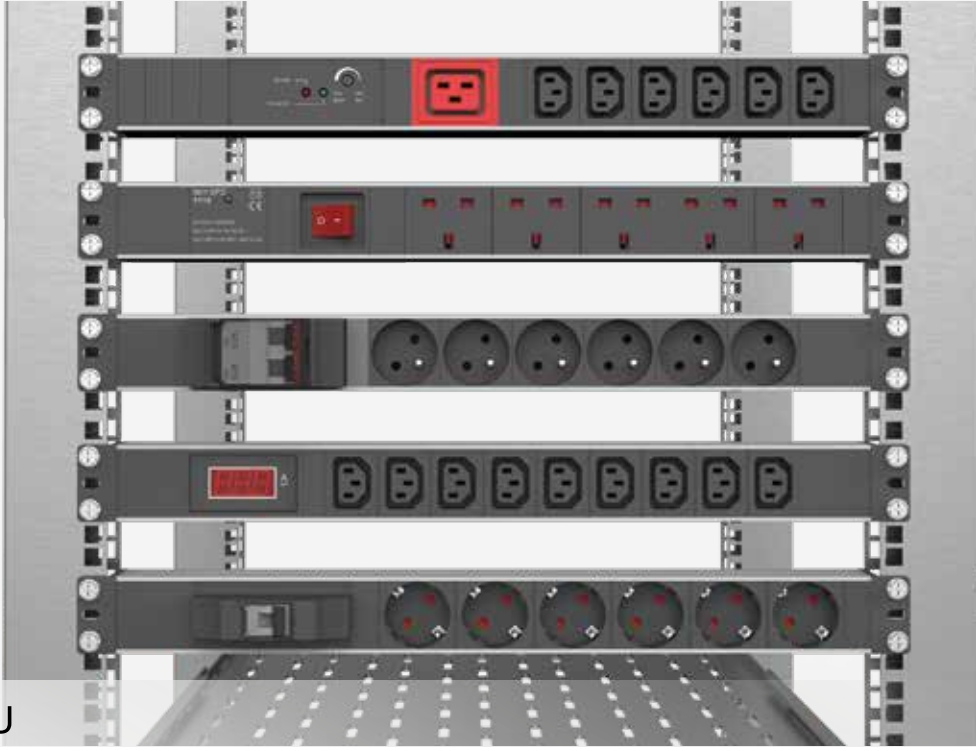

Standart



Ürün Kodu

- 1400.1070.000
- 19 1400.1080.000
- 1400.1090.000
- 1400.2070.000
- 19 1400.2080.000
- 1400.2090.000

Açıklama

- 7 Şebeke
- 8 Şebeke
- 9 Şebeke
- 7 UPS
- 8 UPS
- 9 UPS

Fiyat

- 142,00 TL
- 156,00 TL
- 170,00 TL
- 159,00 TL
- 175,00 TL
- 190,50 TL

Gerilim Korumalı



Ürün Kodu

- 1404.1060.000
- 19 1404.1070.000
- 1404.1080.000
- 1404.2060.000
- 19 1404.2070.000
- 1404.2080.000

Açıklama

- 6 Şebeke + Gerilim Koruma
- 7 Şebeke + Gerilim Koruma
- 8 Şebeke + Gerilim Koruma
- 6 UPS + Gerilim Koruma
- 7 UPS + Gerilim Koruma
- 8 UPS + Gerilim Koruma

Fiyat

- 224,50 TL
- 244,00 TL
- 258,00 TL
- 241,00 TL
- 262,00 TL
- 270,00 TL

Anahtarlı



Ürün Kodu

- 1403.1060.000
- 19 1403.1070.000
- 1403.1080.000
- 1403.2060.000
- 19 1403.2070.000
- 1403.2080.000

Açıklama

- 6 Şebeke + Anahtar
- 7 Şebeke + Anahtar
- 8 Şebeke + Anahtar
- 6 UPS + Anahtar
- 7 UPS + Anahtar
- 8 UPS + Anahtar

Fiyat

- 146,00 TL
- 163,00 TL
- 177,00 TL
- 160,00 TL
- 181,00 TL
- 196,50 TL

Tek Sigortalı



Ürün Kodu

- 1401.1040.000
- 19 1401.1060.000
- 1401.1080.000
- 1401.2040.000
- 19 1401.2060.000
- 1401.2080.000

Açıklama

- 4 Şebeke + Tekli Sigorta
- 6 Şebeke + Tekli Sigorta
- 8 Şebeke + Tekli Sigorta
- 4 UPS + Tekli Sigorta
- 6 UPS + Tekli Sigorta
- 8 UPS + Tekli Sigorta

Fiyat

- 155,00 TL
- 175,50 TL
- 206,50 TL
- 166,00 TL
- 189,50 TL
- 226,00 TL

Çift Sigortalı



Ürün Kodu

- 1411.1040.000
- 19 1411.1060.000
- 1411.1080.000
- 1411.2040.000
- 19 1411.2060.000
- 1411.2080.000

Açıklama

- 4 Şebeke + Çift Sigortalı
- 6 Şebeke + Çift Sigortalı
- 8 Şebeke + Çift Sigortalı
- 4 UPS + Çift Sigortalı
- 6 UPS + Çift Sigortalı
- 8 UPS + Çift Sigortalı

Fiyat

- 235,00 TL
- 260,00 TL
- 290,00 TL
- 250,00 TL
- 270,00 TL
- 310,00 TL

Butonlu Akım Korumalı



Ürün Kodu

- 1412.1060.000
- 19 1412.1070.000
- 1412.1080.000
- 1412.2060.000
- 19 1412.2070.000
- 1412.2080.000

Açıklama

- 6 Şebeke + Akım Koruma
- 7 Şebeke + Akım Koruma
- 8 Şebeke + Akım Koruma
- 6 UPS + Akım Koruma
- 7 UPS + Akım Koruma
- 8 UPS + Akım Koruma

Fiyat

- 164,00 TL
- 181,00 TL
- 195,00 TL
- 178,00 TL
- 199,00 TL
- 215,00 TL

Anahtarlı Akım Korumalı



Ürün Kodu

- 1413.1060.000
- 19 1413.1070.000
- 1413.1080.000
- 1413.2060.000
- 19 1413.2070.000
- 1413.2080.000

Açıklama

- 6 Şebeke + Anahtarlı Akım Koruma
- 7 Şebeke + Anahtarlı Akım Koruma
- 8 Şebeke + Anahtarlı Akım Koruma
- 6 UPS + Anahtarlı Akım Koruma
- 7 UPS + Anahtarlı Akım Koruma
- 8 UPS + Anahtarlı Akım Koruma

Fiyat

- 167,50 TL
- 184,50 TL
- 198,50 TL
- 181,50 TL
- 202,00 TL
- 218,00 TL

1U Kapak Modelleri



TEM 1U GST PDU



1411.0000.003
Çift Sigorta Modülü
240,00 TL



1414.0000.003
SPD + EMI-RFI Filtre Modülü
475,00 TL



1415.0000.003
SPD + Anahtar Modülü
253,00 TL



1400.1020.0202.3
2'li USB Şarj + 2 Şebeke
317,00 TL



1400.1040.003
4 Şebeke
163,00 TL



1403.1030.003
3 Şebeke + Anahtar
177,00 TL



725.3150.893
GST (Dişi + Erkek)
3x1,5 H05VV-F 3m
60,50 TL



725.3150.913
3m GST Dişi + Unischuko
3x1,5 H05VV-F 3m
44,00 TL



725.3150.933
3m GST Dişi + C14
3x1,5 H05VV-F 3m
46,00 TL

TEM U62 PDU



Boş Alüminyum Gövde



Ürün Kodu

Açıklama

Fiyat

1620.0010.000	10 x 22.5 Modül	80,00 TL
1620.0012.000	12 x 22.5 Modül	92,00 TL
1620.0014.000	14 x 22.5 Modül	103,00 TL
1620.0016.000	16 x 22.5 Modül	115,00 TL
1620.0018.000	18 x 22.5 Modül	126,00 TL
1620.0020.000	20 x 22.5 Modül	138,00 TL

Örnek Ürünler



1620.1232.8711.0
3 Şebeke + 2 UPS + 1 Cat6 + 1 Cat3
277,00 TL



1620.1222.8722.0
2 Şebeke + 2 UPS + 2 Cat6 + 2 Cat3
345,00 TL



1620.1222.872111.0
2 Şebeke + 2 UPS + 1 Cat6 + 1 Cat 3
+ 2'li USB Şarj
387,00 TL



1620.1223.8721.0
2 Şebeke + 3 UPS + 2 Cat6 + 1 Cat3
327,00 TL



1620.1233.8711.0
3 Şebeke + 3 UPS + 1 Cat6 + 1 Cat3
300,00 TL



1620.1030.153111.0
3 Şebeke + 1 VGA + 1 HDMI + 1 USB Şarj
470,00 TL



TEM U42 PDU

Standart



Ürün Kodu

- 1420.1070.000
- 19 1420.1080.000
- 1420.1090.000
- 1420.2070.000
- 19 1420.2080.000
- 1420.2090.000

Açıklama

- 7 Şebeke
- 8 Şebeke
- 9 Şebeke
- 7 UPS
- 8 UPS
- 9 UPS

Fiyat

- 221,00 TL
- 237,00 TL
- 253,00 TL
- 223,00 TL
- 243,00 TL
- 263,00 TL

Tek Sigortalı



Ürün Kodu

- 1421.1040.000
- 19 1421.1060.000
- 1421.1080.000
- 1421.2040.000
- 19 1421.2060.000
- 1421.2080.000

Açıklama

- 4 Şebeke + Tekli Sigorta
- 6 Şebeke + Tekli Sigorta
- 8 Şebeke + Tekli Sigorta
- 4 UPS + Tekli Sigorta
- 6 UPS + Tekli Sigorta
- 8 UPS + Tekli Sigorta

Fiyat

- 215,00 TL
- 260,00 TL
- 305,00 TL
- 218,00 TL
- 226,00 TL
- 314,00 TL

Anahtarlı



Ürün Kodu

- 1423.1060.000
- 19 1423.1070.000
- 1423.1080.000
- 1423.2060.000
- 19 1423.2070.000
- 1423.2080.000

Açıklama

- 6 Şebeke + Anahtar
- 7 Şebeke + Anahtar
- 8 Şebeke + Anahtar
- 6 UPS + Anahtar
- 7 UPS + Anahtar
- 8 UPS + Anahtar

Fiyat

- 213,00 TL
- 236,00 TL
- 259,00 TL
- 216,00 TL
- 244,00 TL
- 272,00 TL



1420.1223.8721.0
2 Şebeke + 3 UPS + 2 Cat6 + 1 Cat3
302,00 TL



1420.1233.8711.0
3 Şebeke + 3 UPS + 1 Cat6 + 1 Cat3
277,00 TL



1420.1232.8711.0
3 Şebeke + 2 UPS + 1 Cat6 + 1 Cat3
254,00 TL



1420.1222.8722.0
2 Şebeke + 2 UPS + 2 Cat6 + 2 Cat3
319,00 TL



1422.1050.000
5 Şebeke + Çift Sigortalı
300,00 TL



1420.1040.110
4 Şebeke + 2'li USB Şarj
260,00 TL



1430.1223.8721.0
2 Şebeke + 3 UPS + 2 Cat6 + 1 Cat3
345,00 TL



1430.1222.8722.0
2 Şebeke + 2 UPS + 2 Cat6 + 2 Cat3
356,00 TL



1430.1232.8711.0
3 Şebeke + 2 UPS + 1 Cat6 + 1 Cat3
305,00 TL

TEM G70 Masaüstü PDU

Ürün Kodu

Açıklama

^a(mm)

Fiyat

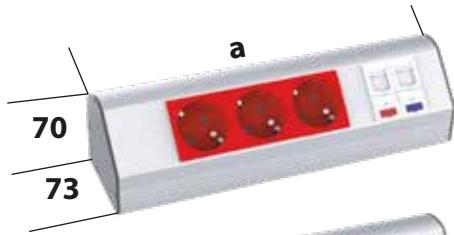

1700.2030.8711.0

3 UPS + 1 Cat6 + 1 Cat3

280

230,00 TL



1700.1222.8711.0

2 Şebeke + 2 UPS
+ 1 Cat6 + 1 Cat3

348

267,00 TL



1700.2631.8711.0

3 UPS + 1 Üniversal Priz
+ 1 Cat6 + 1 Cat3

347,5

291,00 TL



1700.2030.187111.0

3 UPS + 1 Cat6 + 1 Cat3
+ 1 USB Şarj

302,5

355,00 TL

* a = yan kapaklar dahil toplam ürün ölçüsü

Montaj Ayağı

Ürün Kodu

Açıklama

^a(mm)

^b(mm)

Fiyat

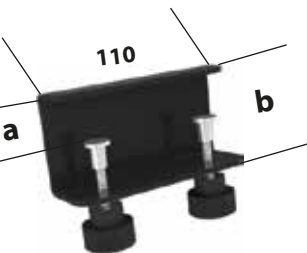

740.050.030

Küçük Boy

$18 \leq a \leq 35$

56

90,00 TL

740.050.070

Büyük Boy

$35 \leq a \leq 75$

96

130,00 TL

* a = Masa kalınlığı ölçüsü

Kolon Kanal Modelleri

U62

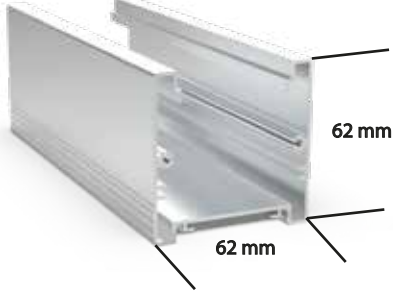

U62 Çiftli



H100

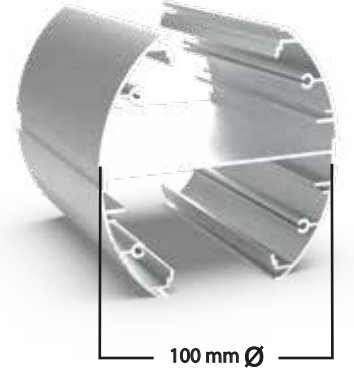

H100

1400.1244.8722.0
4 Şebeke + 4 UPS +
2 Cat6 + 2 Cat3
502,00 TL



H100

1400.1040.8142.0
4 Şebeke + 2x2'li USB Şarj
+ 4 Cat6
565,00 TL



H100

1400.1020.135222.0
2 Şebeke + 2 USB Şarj +
2 VGA + 2 HDMI
980,00 TL



H100

1400.1040.120
2 Şebeke
2 USB
525,00 TL

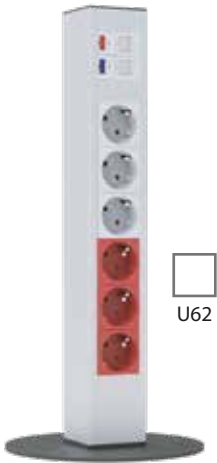

U62

1100.1233.8711.0
3 Şebeke + 3 UPS +
1 Cat 6 + 1 Cat 3
366,00 TL



U62 Çiftli

1000.1244.136111.0
4 Şebeke + 4 UPS + 2 USB Şarj
+ 2 HDMI + 2 RCA
1040,00 TL



U62

1100.1222.8200.0
2 Şebeke + 2 UPS
2 Cat6
325,00 TL



U62

1100.1040.3511.0
4 Şebeke + 1 HDMI
+ 1 VGA
490,00 TL

H100 Tavan Bağlantı Aparatı



H100 Kolon Ayağı



TEM 044 PDU

	Ürün Kodu	Açıklama	a (mm)	Fiyat
	1800.1020.210	2 Şebeke + 2'li USB Şarj	232	349,00 TL
	1800.2020.210	2 UPS + 2'li USB Şarj	232	355,00 TL
	1800.1030.000	3 Şebeke	205	201,00 TL
	1800.2030.000	3 UPS	205	208,00 TL
	1804.1020.210	2 Şebeke + 2'li USB Şarj + Akım Koruma	307	451,00 TL
	1804.2020.210	2 UPS + 2'li USB Şarj + Akım Koruma	307	457,00 TL
	1804.1030.000	3 Şebeke + Akım Koruma	280	289,00 TL
	1804.2030.000	3 UPS + Akım Koruma	280	296,00 TL

Masa kesim ölçüsü Ø60mm
Kullanılmadıkça yer kaplamayan grup priz
Özel kilit mekanizması



TEM Güç Çerçevesi

Boş Alüminyum Gövde

Ürün Kodu

Açıklama

Kesim Ölçüsü

a+7(mm)

a
(mm)

Fiyat

1720.0010.000

10 x 22,5 Modül

232 x 55

225

74,00 TL

1720.0012.000

12 x 22,5 Modül

277 x 55

270

84,00 TL

1720.0014.000

14 x 22,5 Modül

322 x 55

315

94,00 TL

1720.0016.000

16 x 22,5 Modül

367 x 55

360

104,00 TL

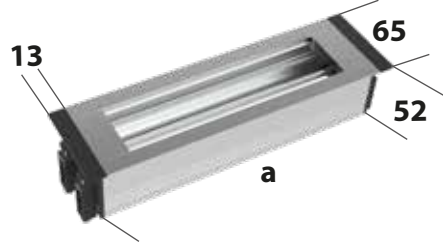

* a = yan kapaklar hariç net alüminyum ölçüsü
a+26 = Toplam ürün ölçüsü

Ürün Kodu

Açıklama

Kesim Ölçüsü

a+6(mm)

a
(mm)

Fiyat

1720.1020.110

2 Şebeke + USB Şarj

208,5 x 55

202,5

204,00 TL

1720.2030.8711.0

3 UPS + 1 Cat6 + 1 Cat3

276 x 55

270

196,00 TL

1720.4020.1511.0

2 İngiliz Prizi + 1 USB Şarj
+ VGA

243 x 55

225

279,00 TL

1720.1222.0802.0

2 Şebeke + 2 UPS +
2 Cat6

343,5 x 55

337,5

205,00 TL





TEM Masa Kapağı

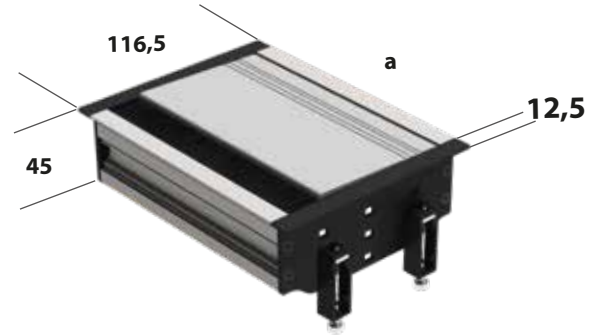
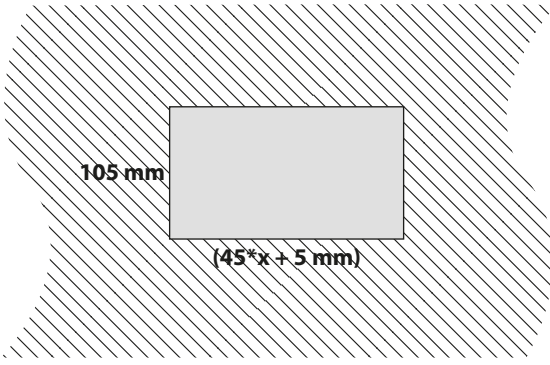

Boş Alüminyum Gövde

Ürün Kodu

Açıklama

Kesim Ölçüsü

a+7(mm)

a
(mm)

Fiyat

1710.0010.000

10 x 22,5 Modül

232 x 105

225

95,00 TL

1710.0012.000

12 x 22,5 Modül

277 x 105

270

110,00 TL

1710.0014.000

14 x 22,5 Modül

322 x 105

315

125,00 TL

1710.0016.000

16 x 22,5 Modül

367 x 105

360

140,00 TL

* a = yan kapaklar hariç net alüminyum ölçüsü
a+25 = Toplam ürün ölçüsü

TEM Kapaklı Güç Çerçevesi



Boş Alüminyum Gövde	Ürün Kodu	Açıklama	Kesim Ölçüsü		Fiyat
			a+35(mm)	^a (mm)	
	1730.0010.0	10 x 22,5 Modül	260x105	225	162,00 TL
	1730.0012.0	12 x 22,5 Modül	305x105	270	184,00 TL
	1730.0014.0	14 x 22,5 Modül	350x105	315	206,00 TL
	1730.0016.0	16 x 22,5 Modül	395x105	360	228,00 TL

* a = yan kapaklar hariç net alüminyum ölçüsü
a+56 = Toplam ürün ölçüsü

Örnek Ürünler	Ürün Kodu	Açıklama	Kesim Ölçüsü		Fiyat
			a+35(mm)	^a (mm)	
	1730.1020.8711.0	2 Şebeke + 1 USB Şarj	260 x 105	225	312,00 TL
	1730.1020.110	2 Şebeke + 1 Cat6 + 1 Cat3	237,5 x 105	202,5	277,00 TL
	1730.1222.8711.0	2 Şebeke + 2 UPS + 1 Cat6 + 1 Cat3	372,5 x 105	337,5	382,00 TL
	1730.1631.210	3 Şebeke + 1 Üniversal Priz + 2'li USB Şarj	395 x 105	360	559,00 TL



TEM Yatay Masa Grubu

Boş Alüminyum Gövde	Ürün Kodu	Açıklama	Kesim Ölçüsü		Fiyat
			a+70(mm)	^a (mm)	
	1740.0010.000	10 x 22.5 Modül	295 x 135	225	296,00 TL
	1740.0012.000	12 x 22.5 Modül	340 x 135	270	315,00 TL
	1740.0014.000	14 x 22.5 Modül	385 x 135	315	335,00 TL
	1740.0016.000	16 x 22.5 Modül	430 x 135	360	354,00 TL

* **a** = Boş kanal içi kullanılabilirlik ölçüsü
a+70 = Ürün kesim ölçüsü
a+100 = Toplam ürün ölçüsü

Örnek Ürünler	Ürün Kodu	Açıklama	Kesim Ölçüsü		Fiyat
			a+70(mm)	^a (mm)	
	1740.1040.820	4 Şebeke + 2 Cat6	362,5x135	292,5	515,00 TL
	1740.1222.8711.0	2 Şebeke + 2 UPS + 1 Cat6 +1 Cat3	385x135	315	516,00 TL
	1740.1224.842	2 Şebeke + 4 UPS + 4 Cat6 + Soket Girişli	520x135	450	622,00 TL
	1740.1233.840	3 Şebeke + 3 UPS + 4 Cat6	520x135	450	593,00 TL



Kontrol Seçenekleri

- PIR Hareket Sensörü
- IR Yaklaşım Kapı Sensörü
- IR Yaklaşım Aç Kapa
- Dokunmatik Aç Kapa
- Dokunmatik 3 Kademeli Dimmer
- On / Off Anahtar

TEM Aydınlatma

● Işık Rengi: 6500 K / 3000 K

● Giriş: 220 V Sürücülü 100/200 V AC
220 V Sürücüsüz 220 V AC
24 V Sürücüsüz 24 V AC

● Montaj: Askılı
Vidalı
Mıknatıslı

Standart



	Ürün Kodu	Açıklama	Mıknatıssız Fiyat	Mıknatıslı Fiyat
220 V Sürücüsüz	1405.1.0030.X1	35cm 14W 1m Kablolu	305,00 TL	361,00 TL
	1405.1.0050.X1	55cm 18W 1m Kablolu	370,00 TL	426,00 TL
220 V Sürücülü	1405.2.0030.X1	35cm 8,4W 1m Kablolu	310,00 TL	366,00 TL
	1405.2.0050.X1	55cm 14W 1m Kablolu	385,00 TL	441,00 TL
24 V Sürücüsüz	1405.4.0030.X1	35cm 8,4W 1m Kablolu	210,00 TL	266,00 TL
	1405.4.0050.X1	55cm 14W 1m Kablolu	285,00 TL	341,00 TL

X = 0 Mıknatıssız

X = 1 Mıknatıslı

On - Off Anahtarlı



	Ürün Kodu	Açıklama	Mıknatıssız Fiyat	Mıknatıslı Fiyat
220 V Sürücüsüz	1405.1.0130.X1	35cm 14W 1m Kablolu	320,00 TL	376,00 TL
	1405.1.0150.X1	55cm 18W 1m Kablolu	385,00 TL	441,00 TL
220 V Sürücülü	1405.2.0130.X1	35cm 8,4W 1m Kablolu	325,00 TL	381,00 TL
	1405.2.0150.X1	55cm 14W 1m Kablolu	400,00 TL	456,00 TL
24 V Sürücüsüz	1405.4.0130.X1	35cm 8,4W 1m Kablolu	225,00 TL	281,00 TL
	1405.4.0150.X1	55cm 14W 1m Kablolu	300,00 TL	356,00 TL

X = 0 Mıknatıssız

X = 1 Mıknatıslı

Dokunmatik Aç - Kapa



	Ürün Kodu	Açıklama	Mıknatıssız Fiyat	Mıknatıslı Fiyat
220 V Sürücüsüz	1405.1.0230.X1	35cm 14W 1m Kablolu	375,00 TL	431,00 TL
	1405.2.0230.X1	35cm 8,4W 1m Kablolu	380,00 TL	436,00 TL
220 V Sürücülü	1405.2.0250.X1	55cm 14W 1m Kablolu	455,00 TL	511,00 TL
	1405.4.0230.X1	35cm 8,4W 1m Kablolu	280,00 TL	336,00 TL
24 V Sürücüsüz	1405.4.0250.X1	55cm 14W 1m Kablolu	355,00 TL	411,00 TL

X = 0 Mıknatıssız

X = 1 Mıknatıslı

PIR Hareket Sensörü



	Ürün Kodu	Açıklama	Mıknatıssız Fiyat	Mıknatıslı Fiyat
220 V Sürücüsüz	1405.1.0330.X1	35cm 14W 1m Kablolu	480,00 TL	536,00 TL
	1405.1.0350.X1	55cm 18W 1m Kablolu	545,00 TL	601,00 TL
220 V Sürücülü	1405.2.0330.X1	35cm 8,4W 1m Kablolu	485,00 TL	541,00 TL
	1405.2.0350.X1	55cm 14W 1m Kablolu	560,00 TL	616,00 TL
24 V Sürücüsüz	1405.4.0330.X1	35cm 8,4W 1m Kablolu	385,00 TL	441,00 TL
	1405.4.0350.X1	55cm 14W 1m Kablolu	460,00 TL	516,00 TL

X = 0 Mıknatıssız

X = 1 Mıknatıslı

Yaklaşım Kapı Sensörü	Ürün Kodu	Açıklama	Mıknatıssız Fiyat	Mıknatıslı Fiyat
220 V Sürücülü	1405.2.0430.X1	35cm 8,4W 1m Kablolu	480,00 TL	536,00 TL
	1405.2.0450.X1	55cm 14W 1m Kablolu	555,00 TL	611,00 TL
24 V Sürücüsüz	1405.4.0430.X1	35cm 8,4W 1m Kablolu	380,00 TL	436,00 TL
	1405.4.0450.X1	55cm 14W 1m Kablolu	455,00 TL	511,00 TL
	X = 0 Mıknatıssız			
	X = 1 Mıknatıslı			

3 Kademeli Dimmer	Ürün Kodu	Açıklama	Mıknatıssız Fiyat	Mıknatıslı Fiyat
220 V Sürücülü	1405.2.0630.X1	35cm 8,4W 1m Kablolu	380,00 TL	436,00 TL
	1405.2.0650.X1	55cm 14W 1m Kablolu	455,00 TL	511,00 TL
24 V Sürücüsüz	1405.4.0630.X1	35cm 8,4W 1m Kablolu	280,00 TL	336,00 TL
	1405.4.0650.X1	55cm 14W 1m Kablolu	355,00 TL	411,00 TL
	X = 0 Mıknatıssız			
	X = 1 Mıknatıslı			

IR Yaklaşım Aç - Kapa	Ürün Kodu	Açıklama	Mıknatıssız Fiyat	Mıknatıslı Fiyat
220 V Sürücülü	1405.2.0530.X1	35cm 8,4W 1m Kablolu	480,00 TL	536,00 TL
	1405.2.0550.X1	55cm 14W 1m Kablolu	555,00 TL	611,00 TL
24 V Sürücüsüz	1405.4.0530.X1	35cm 8,4W 1m Kablolu	380,00 TL	436,00 TL
	1405.4.0550.X1	55cm 14W 1m Kablolu	455,00 TL	511,00 TL
	X = 0 Mıknatıssız			
	X = 1 Mıknatıslı			

U20 Aydınlatma	Ürün Kodu	Açıklama	Mıknatıssız Fiyat	Mıknatıslı Fiyat
220 V	120X.243.04.36	220V 1m Kablolu + 35cm 5W	85,00 TL	95,00 TL
	120X.245.07.60	220V 1m Kablolu + 41cm 6W	83,00 TL	90,00 TL
	120X.2410.14.120	220V 1m Kablolu + 52cm 10W	98,00 TL	105,00 TL
24V	120X.223.05.40	24V 1m Kablolu + 20cm 4.3W	38,00 TL	43,00 TL
	120X.224.06.48	24V 1m Kablolu + 30cm 4.3W	57,00 TL	64,00 TL
	120X.225.10.80	24V 1m Kablolu + 50cm 7.2W	97,00 TL	105,00 TL
	120X.242.04.36	24V 1m Kablolu + 100cm 14.1W	156,00 TL	170,00 TL
		X = 0 Mıknatıssız		
	X = 1 Mıknatıslı			



TEM Linear Armatür

● Işık Rengi: 6500 K / 3000 K

● Giriş: 220 V Sürüclü 100/200 V AC
24 V Sürücüsüz 24 V AC

● Montaj: Askılı
Vidalı
Mıknatıslı

TİP 1U

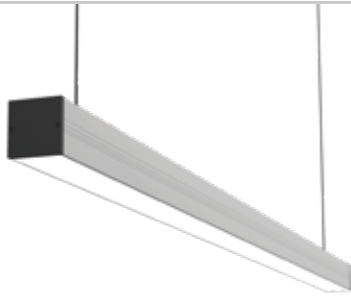

	Ürün Kodu	Açıklama	Fiyat
220 V Sürüclü	14025.2.0060	60cm 16,8W	445,00 TL
	14025.2.0090	90cm 25,2W	575,00 TL
	14025.2.00120	120cm 33,6W	730,00 TL
	14025.2.00150	150cm 42W	860,00 TL
24 V	14025.4.0060	60cm 16,8W	345,00 TL
	14025.4.0090	90cm 25,2W	475,00 TL
	14025.4.00120	120cm 33,6W	600,00 TL
	14025.4.00150	150cm 42W	730,00 TL

TİP C

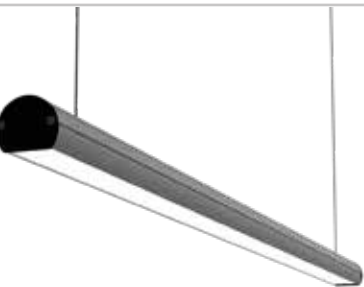

	Ürün Kodu	Açıklama	Fiyat
220 V Sürüclü	14425.2.0060	60cm 16,8W	445,00 TL
	14425.2.0090	90cm 25,2W	575,00 TL
	14425.2.00120	120cm 33,6W	730,00 TL
	14425.2.00150	150cm 42W	860,00 TL
24 V	14425.4.0060	60cm 16,8W	345,00 TL
	14425.4.0090	90cm 25,2W	475,00 TL
	14425.4.00120	120cm 33,6W	600,00 TL
	14425.4.00150	150cm 42W	730,00 TL

Yan Kapak Seçenekleri

Düz Yan Kapak
Vidalı Yan Kapak
Gst Soketli Yan Kapak

Opsiyonel Sinyal Led

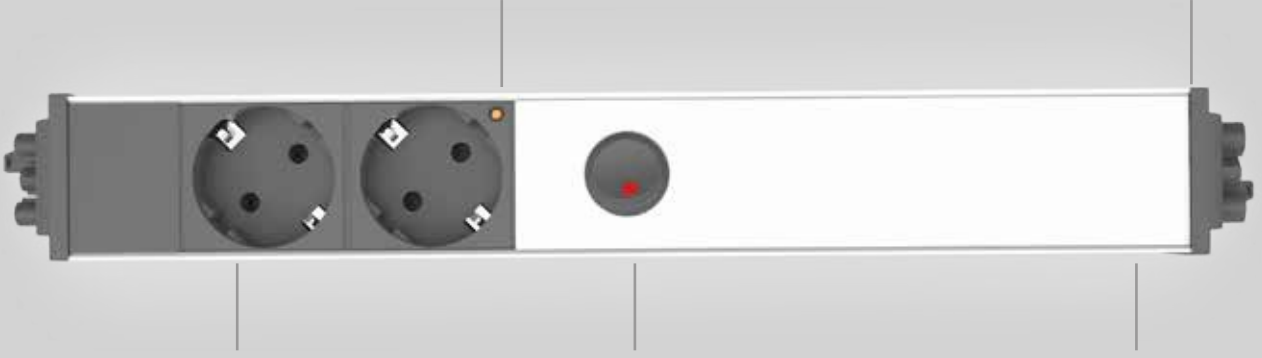

Priz Seçenekleri

Şebeke
UPS
İngiliz
Fransız
IEC C13 / C19

Kontrol Seçenekleri

On / Off Anahtar
Sensör
Anahtar + Kumanda Kablosu

LED Şenekleri

13 cm LED
30 cm LED
50 cm LED

TEM Prizli Aydınlatma

● Işık Rengi: 6500 K / 3000 K

● Giriş: 220 V Sürücülü 100/200 V AC
24 V Sürücüsüz 220 V AC

● Montaj: Askılı
Mıknatıslı

Tip 1U



220 V Sürücüsüz

Ürün Kodu

Açıklama

Mıknatıssız
Fiyat

Mıknatıslı
Fiyat

1405.1013.1020.X0

2 Şebeke + 13cm LED + 3m Kablo

200,00 TL

256,00 TL

1405.1013.2020.X0

2 UPS + 13cm LED + 3m Kablo

210,00 TL

266,00 TL

1405.1030.1020.X0

2 Şebeke + 30cm LED + 3m Kablo

310,00 TL

366,00 TL

1405.1030.2020.X0

2 UPS + 30cm LED + 3m Kablo

320,00 TL

376,00 TL

220 V Sürücülü

1405.2030.1020.X0

2 Şebeke + 30cm LED + 3m Kablo

340,00 TL

396,00 TL

1405.2030.2020.X0

2 UPS + 30cm LED + 3m Kablo

350,00 TL

406,00 TL

X = 0 Mıknatıssız

X = 1 Mıknatıslı

Tip G70



220 V Sürücüsüz

Ürün Kodu

Açıklama

Fiyat

1705.1030.1020.X0

2 Şebeke + 30cm LED + Kablosuz

760,00 TL

1705.1030.1040.X0

4 Şebeke + 30cm LED + Kablosuz

435,00 TL

1705.1050.1020.X0

2 Şebeke + 50cm LED + Kablosuz

485,00 TL

1705.1050.1040.X0

4 Şebeke + 50cm LED + Kablosuz

540,00 TL

220 V Sürücülü

1705.2030.1020.X0

2 Şebeke + 30cm LED + Kablosuz

410,00 TL

1705.2030.1040.X0

4 Şebeke + 30cm LED + Kablosuz

440,00 TL

1705.2050.1020.X0

2 Şebeke + 50cm LED + Kablosuz

520,00 TL

1705.2050.1040.X0

4 Şebeke + 50cm LED + Kablosuz

555,00 TL

X = 0 Mıknatıssız

X = 1 Mıknatıslı

	Ürün Kodu	Açıklama	Modül	Masa Kesim Ölçüsü		B.Fiyat
				a	b	
	800.025.02X	Priz Kasası (Fırçalı-Gri, Siyah, Beyaz)	2.5x45	126	175	190,00 TL
	800.025.022	Priz Kasası (Metalik Kaplama)				250,00 TL
	800.025.12X	Priz Kasası (Fırçalı-Gri, Siyah, Beyaz)	2.5x45	80	170	160,00 TL
	800.025.122	Priz Kasası (Metalik Kaplama)				220,00 TL
	800.045.02X	Priz Kasası (Fırçalı-Gri, Siyah)	4.5x45	127	253	170,00 TL
	800.045.022	Priz Kasası (Fırçalı - Metalik Kaplama)				230,00 TL
	800.045.12X	Priz Kasası (Fırçalı-Gri, Siyah)	4.5x45	127	253	250,00 TL
	800.045.122	Priz Kasası (Fırçalı - Metalik Kaplama)				310,00 TL
	800.050.02X	Priz Kasası (Fırçalı-Gri, Siyah, Beyaz)	5x45	126	175	205,00 TL
	800.050.022	Priz Kasası (Metalik Kaplama)				265,00 TL
	800.090.02X	Priz Kasası (Fırçalı-Gri, Siyah)	9x45	127	253	265,00 TL
	800.090.022	Priz Kasası (Fırçalı - Metalik Kaplama)				325,00 TL

X = 1 Gri X = 3 Siyah X = 6 Beyaz

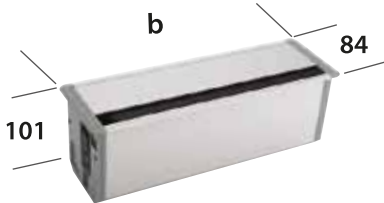

Ürün Kodu	Modül	b	Fiyat
810.020.01X	2x45	132	225,00 TL
810.030.01X	3x45	171	275,00 TL
810.040.01X	4x45	238	330,00 TL
810.050.01X	5x45	279	370,00 TL
810.060.01X	6x45	342	415,00 TL
810.070.01X	7x45	387	445,00 TL
810.080.01X	8x45	449	480,00 TL
810.090.01X	9x45	474	510,00 TL
810.0100.01X	10x45	534	540,00 TL

X = 1 Eloksal X = 3 Siyah X = 6 Beyaz

Tüm ölçüler mm cinsindedir.



Döşeme Altı Buat

182,00 TL



205.352.000

Döşeme Altı Priz Kutusu (Boş Kutu)
Kapasite 18 Adet 22.5 Modül

170,00 TL



206.252.000

Ürün Kodu	Ölçü(mm)	Ağırlık(Kg)
205.352.000	352x352	2.563
206.252.000	252x252	1.461

113x210mm Dahili Priz Kutuları



210.0000.0000
113x210x70mm
46,00 TL



210.1200.4400
4 Şebeke + 4 UPS
176,00 TL



212.1000.6000
6 Şebeke + 2'li Sigorta Yeri
116,00 TL

210x280mm Dahili Priz Kutuları



280.0000.0000
210x280x70mm
80,00 TL



280.1200.6600
6 Şebeke + 6 UPS
252,00 TL



282.1200.6300
6 Şebeke + 3 UPS + 2'li Sigorta Yeri
210,00 TL





250.216.150
Vidalı Şebeke Prizi 45°
16,00 TL



250.316.150
Vidalı UPS Prizi 45°
19,00 TL



245.216.150
Tırnaklı Tek Klemensli Şebeke Prizi
16,00 TL



245.316.150
Tırnaklı Tek Klemensli UPS Prizi
19,00 TL



246.216.150
Tırnaklı Tek Klemensli
Şebeke Prizi 45°
16,00 TL



246.316.150
Tırnaklı Tek Klemensli
UPS Prizi 45°
19,00 TL



345.216.150
Tırnaklı Çift Klemensli
Şebeke Prizi
16,00 TL



345.316.150
Tırnaklı Çift Klemensli
UPS Prizi
19,00 TL



346.216.150
Tırnaklı Çift Klemensli
Şebeke Prizi 45°
16,00 TL



346.316.150
Tırnaklı Çift Klemensli
UPS Prizi 45°
19,00 TL



247.216.150
Tırnaklı Tek Klemensli
Fransız Prizi 45°
19,00 TL



347.216.151
Tırnaklı Tek Klemensli
Fransız Prizi
19,00 TL

Kapaklı Prizler



Çift tırnak sayesinde dikey ve yatay kullanımlara uygundur.



350.216.160
Çift Tırnaklı Çift Klemensli
Kapaklı Şebeke Prizi
19,00 TL



350.316.160
Çift Tırnaklı Çift Klemensli
Kapaklı UPS Prizi
24,00 TL

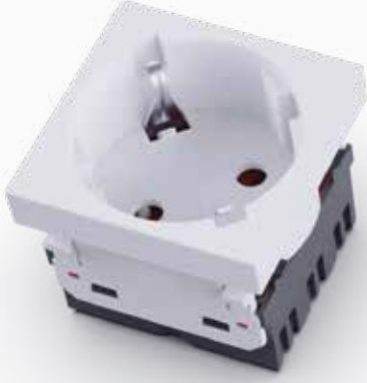

350.216.150
Çift Tırnaklı Çift Klemensli
Şebeke Prizi 45°
17,00 TL



740.061.002
Priz Birleştirme
Aparatı
7,00 TL



350.316.150
Çift Tırnaklı Çift Klemensli
UPS Prizi 45°
21,00 TL



721.170.150
45x45mm Universal Priz
33,00 TL



721.160.150
45x45mm Amerikan Prizi
28,00 TL



721.130.150
45x45mm İngiliz Prizi
25,00 TL



721.130.151
51x45mm İngiliz Prizi
26,00 TL



721.130.300
İngiliz Fişi
31,00 TL



ŞEBEKE TİP

16A 2P+E 200-250 V~



	Açıklama	Ürün Kodu	B.Fiyat	Çocuk Emniyetli Kod	B.Fiyat
Kablolu	2'li Şebeke Prizi	310.002.003	30,00 TL	310.002.103	34,00 TL
	3'lü Şebeke Prizi	310.003.003	40,00 TL	310.003.103	46,00 TL
	4'lü Şebeke Prizi	310.004.003	51,00 TL	310.004.103	59,00 TL
Klemensli	2'li Şebeke Prizi	311.002.003	37,00 TL	311.002.103	41,00 TL
	3'lü Şebeke Prizi	311.003.003	47,00 TL	311.003.103	53,00 TL
	4'lü Şebeke Prizi	311.004.003	49,00 TL	311.004.103	57,00 TL
Çift Klemensli	2'li Şebeke Prizi	312.002.003	53,00 TL	312.002.103	57,00 TL
	3'lü Şebeke Prizi	312.003.003	62,00 TL	312.003.103	66,00 TL
	4'lü Şebeke Prizi	312.004.003	77,00 TL	312.004.103	81,00 TL

UPS TİP

16A 2P+E 200-250 V~



	Açıklama	Ürün Kodu	B.Fiyat	Çocuk Emniyetli Kod	B.Fiyat
Kablolu	2'li UPS Prizi	320.002.002	35,00 TL	320.002.102	39,00 TL
	3'lü UPS Prizi	320.003.002	46,00 TL	320.003.102	52,00 TL
	4'lü UPS Prizi	320.004.002	60,00 TL	320.004.102	68,00 TL
Klemensli	2'li UPS Prizi	321.002.002	40,00 TL	321.002.102	44,00 TL
	3'lü UPS Prizi	321.003.002	51,00 TL	321.003.102	57,00 TL
	4'lü UPS Prizi	321.004.002	65,00 TL	321.004.102	73,00 TL
Çift Klemensli	2'li UPS Prizi	322.002.002	55,00 TL	322.002.102	59,00 TL
	3'lü UPS Prizi	322.003.002	65,50 TL	322.003.102	69,50 TL
	4'lü UPS Prizi	322.004.002	82,00 TL	322.004.102	86,00 TL

FRANSIZ TİP

16A 2P+E 200-250 V~



	Açıklama	Ürün Kodu	B.Fiyat
Kablolu	2'li Fransız Prizi	350.002.102	39,00 TL
	3'lü Fransız Prizi	350.003.102	55,00 TL
	4'lü Fransız Prizi	350.004.102	65,20 TL
Klemensli	2'li Fransız Prizi	351.002.102	47,00 TL
	3'lü Fransız Prizi	351.003.102	61,00 TL
	4'lü Fransız Prizi	351.004.102	79,00 TL
Çift Klemensli	2'li Fransız Prizi	352.002.102	62,00 TL
	3'lü Fransız Prizi	352.003.102	76,00 TL
	4'lü Fransız Prizi	352.004.102	96,00 TL

BİLGİSAYAR IEC TİP 10A 2P+E 200-250 V~

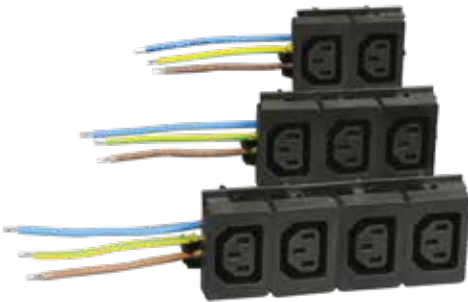

Açıklama	Ürün Kodu	B.Fiyat
2'li Bilgisayar Prizi	330.002.004	34,00 TL
3'lü Bilgisayar Prizi	330.003.004	40,00 TL
4'lü Bilgisayar Prizi	330.004.004	49,00 TL

İNGİLİZ TİP

13A 2P+E 200-250 V~

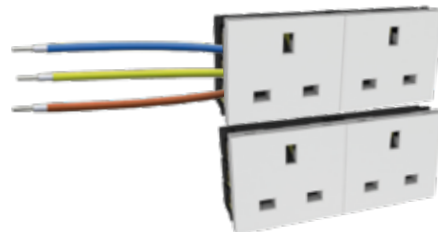

	Açıklama	Ürün Kodu	B.Fiyat
Kablolu	2'li İngiliz Prizi	340.002.003	43,00 TL
	3'lü İngiliz Prizi	340.003.003	50,00 TL
	4'lü İngiliz Prizi	340.004.003	67,00 TL
Çift Klemensli	2'li İngiliz Prizi	342.002.003	61,00 TL
	3'lü İngiliz Prizi	342.003.003	79,00 TL
	4'lü İngiliz Prizi	342.004.003	96,00 TL



720.130.150
IEC C13 10A
Tırnaklı Gövde Priz
7,00 TL



720.130.160
IEC C13 10A
Vidalı Gövde Priz
7,00 TL



720.130.200
IEC C13 10A
Seyyar Priz
12,00 TL



720.140.320
IEC C14 10A
Tırnaklı Gövde Fiş
7,00 TL



720.140.340
IEC C14 10A
Vidalı Gövde Fiş
7,00 TL



720.140.300
IEC C14 10A
Seyyar Fiş
12,00 TL



720.140.321
IEC C14 10A
Gövdede Fiş
12,50 TL



720.190.150
IEC C19 16A
Tırnaklı Gövde Priz
21,00 TL



720.190.160
IEC C19 16A
Vidalı Gövde Priz
21,00 TL



720.190.200
IEC C19 16A
Seyyar Priz
66,00 TL



720.200.320
IEC C20 16A
Tırnaklı Gövde Fiş
25,00 TL



720.240.340
IEC C20 16A
Vidalı Gövde Fiş
25,00 TL



720.200.300
IEC C20 16A
Seyyar Fiş
66,00 TL



720.200.321
IEC C20 16A
Gövdede Fiş
34,00 TL



724.021.000
Seyyar Gst Soket
Dişi / Erkek
21,00 TL



724.011.000
Seyyar Gst Soket
Dişi / Erkek
18,00 TL



724.020.000
GST Soket Dişi
16,00 TL



724.010.000
GST Soket Erkek
13,80 TL

724.000.010
Plastik Kilit



2.5mm² Soket Klemensler



720.400.200 - Beyaz
720.400.201 - Siyah
720.400.202 - Kırmızı
Erkek - Dişi Takım Soketler
23,00 TL



720.500.002 2'li
Klemens
5,00 TL



720.500.003 3'lü
Klemens
6,50 TL



720.500.004 4'lü
Klemens
8,00 TL



720.500.005 5'li
Klemens
10,00 TL

tem SPD 0120 TİP 3 Gerilim Koruma

U_c : 255V - 50-60 Hz

U_{oc} : 5/10 kV

I_n : 2,5/5 kA

U_p : $\leq 1,5$ kV



22.5x45mm

734.612.0120.1

SPD 0120-1(Siyah - Beyaz)

100,00 TL



45x45mm

734.613.0120.1

SPD 0120-1(Siyah - Beyaz)

95,00 TL

Not: Ürünün üzerindeki gösterge ışığı

Yeşil yanıyor ise, ürünün normal çalıştığı,

Kırmızı yanıyor ise, ürünün değiştirilmesi gerektiği anlaşılmalıdır.

tem SPD 1119 TİP 3 Gerilim Koruma

U_c : 255V - 50-60 Hz

U_{oc} : 5 kV

I_n : 3 kA

U_p : ≤ 2 kV

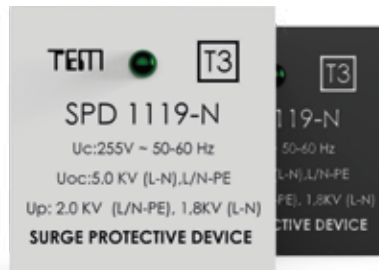

45x45mm

734.613.0120.1N

SPD 0120-1(Siyah - Beyaz)

115,00 TL

Not: Ürünün üzerindeki gösterge ışığı

Yeşil yanıyor ise, ürünün normal çalıştığı,

yanmıyorsa ürünün değiştirilmesi gerektiği anlaşılmalıdır.



TEM Kablosuz Şarj



Fiyat

110,00 TL

USB

5V 2.1A 10,5 W

Kablosuz

5V 5W - 7,5 W

İletim Mesafesi

≤ 8mm
(Önerilen: 2mm / 4mm)

Verimlilik

≥ 73%

Standart

Qi

Şık ve fonksiyonel tasarım

LED güç göstergesi ışığı ile şarj durumunu gösterir.

Kaymaz yüzeyi ile telefonunuzu güvende tutar.

3mm kalınlığa kadar kasa veyahut kılıfı uyumludur..

USB portu ve Kablosuz şarj aynı anda kullanabilme

Aşırı Sıcaklık ve akım koruması

Cihazlarınız için 7,5W'a kadar hızlı kablosuz şarjı destekler.

Yabancı Nesne Algılama (FOOD) özelliği

Renk

Siyah



Gri





715.200.12X
TİP A/C - 30W(max)
45x45mm (Siyah - Beyaz)
265,00 TL

22.5x45mm USB Şarj Cihazları



715.200.20X
TİP A - 2.1A
22.5x45mm (Siyah - Beyaz)
90,00 TL



715.200.11X
TİP A - 2 A
22.5x45mm (Siyah - Beyaz)
135,00 TL



715.200.10X
TİP A - 1 A
22.5x45mm (Siyah - Beyaz)
80,00 TL

45x45mm USB Şarj Cihazları



715.100.10X
TİP A/C - 2.1 A
45x45mm (Siyah - Beyaz)
145,00 TL



715.100.11X
TİP A/A - 2.1 A
45x45mm (Siyah - Beyaz)
125,00 TL

45x45mm Tv Prizler



723.000.150
TV Prizi
25,00 TL



723.000.300
TV Prizi Erkek 9.52mm
25,00 TL



723.000.400
TV Uydu Prizi
27,00 TL

VGA Konnektörleri



715.300.001
6+2 Klemens Girişli
22.5x45mm - Faceplate
55,00 TL



715.300.002
14+2 Klemens Girişli 22.5x45mm
Hızlı Montaj - Faceplate
80,00 TL



715.300.003
Soket Girişli
45x45mm - Faceplate
40,00 TL



715.300.004
Soket Girişli
22.5x45mm - Faceplate
40,00 TL



715.300.005
15 Klemens Girişli
22.5x45mm - Faceplate
40,00 TL



715.300.007
9 Pinli
22.5x45mm Faceplate
35,00 TL



715.300.009
B Soket Girişli
45x45mm - Faceplate
65,00 TL

RCA & STEREO Konnektörleri



715.500.002
RCA Konnektör 22.5x45mm
Klemensli - Faceplate
55,00 TL



715.500.001
RCA Konnektör 22.5x45mm
Klemensli - Faceplate
60,00 TL



715.600.001
Stereo Konnektör 22.5x45mm
Klemensli - Faceplate
60,00 TL

HDMI Konnektörleri



715.400.001
TİP A Dişi - Dişi 90°
22.5x45mm - Faceplate
80,00 TL



715.400.002
TİP A Dişi - Dişi 180°
22.5x45mm - Faceplate
80,00 TL



715.400.003
TİP A Dişi - Dişi Üstten
Giriş-Çıkışlı
22.5x45mm - Faceplate
80,00 TL

HDMI Konnektör



715.400.008
HDMI Konnektör TİP A Dişi-Dişi
45x45mm - Faceplate
110,00 TL

DISPLAY Konnektör



715.700.001
Display Port Konnektör Soket Girişli
45x45mm - Faceplate
110,00 TL

XLR Konnektör



715.600.002
XLR Dişi Soket
45x45mm Klemensli - Faceplate
50,00 TL

USB Konnektörleri



715.200.004
Standart A
USB AF/AF 90°
22.5x45mm - Faceplate
60,00 TL



715.200.005
Standart A
USB AF/AF 180°
22.5x45mm - Faceplate
60,00 TL



715.200.006
Standart A
Klemensli
22.5x45mm - Faceplate
60,00 TL

USB / HDMI Keystone



715.200.001
Standart B
Dişi - Dişi - Keystone
35,00 TL



715.200.002
Standart A
Dişi - Dişi - Keystone
35,00 TL



715.200.003
Standart A
Dişi - Dişi Kablolu - Keystone
75,00 TL



715.400.004
TİP A Dişi - Dişi
Keystone
50,00 TL



715.400.005
TİP A Dişi - Dişi
Kablolu Keystone
110,00 TL



710.100.103
45x45mm Yaylı Kapaklı
1,10 USD



710.100.104
22x45mm Yaylı Kapaklı
1,00 USD



710.100.105
45x45mm Yaylı Kapaklı - Çiftli
2,20 USD



Telefon -Data Konnektörleri
Dişi - Dişi Telefon - Data Konnektörleri



715.100.030
CAT3 TELEFON
2,00 USD



715.100.050
CAT5E DATA
2,00 USD



715.100.060
CAT6 DATA
2,40 USD



715.100.061
CAT6A DATA
7,00 USD



715.200.030
CAT3 TELEFON
3,30 USD



715.200.050
CAT5E DATA
3,60 USD



715.200.060
CAT6 DATA
3,60 USD



715.200.061
CAT6A DATA
5,80 USD



Telefon Data Fişleri



710.100.350
CAT5 DATA Fişi
0,15 USD



710.100.360
CAT6 DATA Fişi
0,50 USD



710.100.332 - 2 PIN
710.100.334 - 4 PIN
710.100.336 - 6PIN
TELEFON Fişi
0,08 USD





708.100.010
50x50mm - Tekli
2,65 TL



708.100.020
50x50mm - Çiftli
2,65 TL



709.100.103
45x45mm
3,00 TL



709.100.104
22.5x45mm
2,65 TL



Kanal Üstü Telefon -Data Kapakları



710.100.107
45x45mm Kapaksız - Çiftli
9,00 TL



710.100.111
22.5x45mm Kapaksız - Tekli
9,00 TL



710.100.106
45x45mm Kapaksız- Tekli
8,00 TL



709.200.104
22x45mm
2,65 TL



709.200.103
45x45mm
3,00 TL

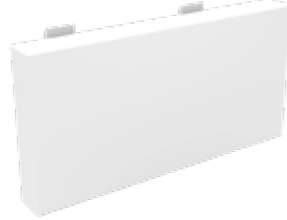

709.200.105
45x90mm
4,50 TL

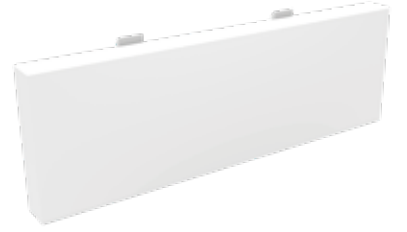

709.200.106
45x135mm
6,00 TL



45x45mm Kanal Üstü Keystone Kapakları



710.100.108
Yükseltme Kapağı
4,15 TL



710.100.109
Keystone - Faceplate - Tekli
7,50 TL



710.100.110
Keystone - Faceplate - Çiftli
8,25 TL



tem Akım Koruma

Akım Deęeri : 16A
Voltaj Deęeri : 125/250 V AC
Yalıtım Direnci : >100MOHM (DC 500V)
Koruma Derecesi : IP40



723.225.016
Butonlu Akım Koruma
22.5x45mm
16,50 TL



723.225.116
Anahtarlı Akım
Koruma 22.5x45mm
16,50 TL

On - Off Anahtarlar



722.045.012
Tekli Anahtar 16A
45x45mm
Işıksız
15,75 TL

722.045.112
Tekli Anahtar 16A
45x45mm
Işıklı
16,50 TL



722.045.011
Çiftli Anahtar
2x10A 45x45mm
Işıksız
23,25 TL

722.045.111
Çiftli Anahtar
2x10A 45x45mm
Işıklı
24,00 TL



722.225.010
Anahtar 10A
22.5x45mm
Işıksız
12,30 TL

722.225.110
Anahtar 10A
22.5x45mm
Işıklı
12,75 TL



722.225.021
Anahtar 16A
22.5x45mm
Işıksız
15,00 TL



722.225.021
Anahtar 16A
22.5x45mm
Işıklı
18,00 TL



722.045.022
Çift Anahtar 2x16A
45x45mm
Işıksız
21,50 TL



722.045.022
Çift Anahtar 2x16A
45x45mm
Işıklı
25,00 TL



Bluetooth 5.0

Android - IOS Uyumlu

Sinyal Gürültü Oranı : 95DB

Çalışma Sıcaklığı : 10 - 40 °C

Çalışma Nemi : 35 ~ 85%

İletişim Uzaklığı : 10m

Frekans Tepkisi : 120Hz - 18KHz



TEM Bluetooth Hoparlör

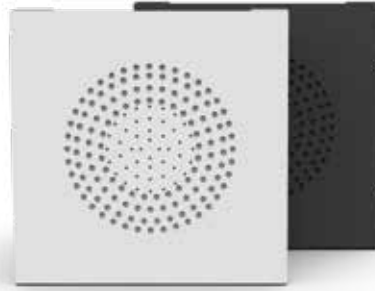

715.200.12X
240V AC / 50-60Hz 0.3A
45x45mm (Siyah - Beyaz)
265,00 TL

Örnek Ürünler



1620.1200.11101
2 Şebeke + 2'li USB Şarj
+ Bluetooth Hoparlör + 450cm Profil
760,00 TL



1620.1200.1182101
2 Şebeke + 2 Cat6 + 2'li USB Şarj
+ Bluetooth Hoparlör + 500cm Profil
855,00 TL



1620.1300.11101
3 Şebeke + 2'li USB Şarj
+ Bluetooth Hoparlör + 550cm Profil
800,00 TL

HDMI Kabloları	Ürün Kodu	Uzunluk	Açıklama	Fiyat
	725.400.001	1.5 m	-	6,00 USD
	725.400.003	3 m	-	12,00 USD
	725.400.005	5 m	-	18,00 USD
	725.400.010	10 m	-	45,00 USD
	725.400.015	15 m	-	54,00 USD
	725.400.020	20 m	-	75,00 USD
	725.400.025	25 m	Chipset'li	180,00 USD
	725.400.030	30 m	Chipset'li	195,00 USD
	725.400.040	40 m	Chipset'li	240,00 USD
	725.400.050	50 m	Chipset'li	270,00 USD

CAT6 KABLoları	Ürün Kodu	Uzunluk	Açıklama	Fiyat
	725.060.001	1 m	UPT 24 AWG	3,25 USD
	725.060.002	2 m	UPT 24 AWG	3,60 USD
	725.060.003	3 m	UPT 24 AWG	6,85 USD
	725.060.005	5 m	UPT 24 AWG	9,75 USD
	725.060.007	7 m	UPT 24 AWG	12,60 USD
	725.060.008	8 m	UPT 24 AWG	14,10 USD
	725.060.010	10 m	UPT 24 AWG	16,95 USD
	725.060.015	15 m	UPT 24 AWG	24,30 USD
	725.060.020	20 m	UPT 24 AWG	31,35 USD
	725.060.030	30 m	UPT 24 AWG	36,75 USD
CAT6 UTP 24 AWG LSOH	725.060.040	40 m	UPT 24 AWG	60,30 USD

	725.061.001	1 m	FTP 24 AWG	5,80 USD
	725.061.002	2 m	FTP 24 AWG	7,45 USD
	725.061.003	3 m	FTP 24 AWG	9,00 USD
	725.061.005	5 m	FTP 24 AWG	12,30 USD
	725.061.007	7 m	FTP 24 AWG	15,50 USD
	725.061.008	8 m	FTP 24 AWG	17,10 USD
	725.061.010	10 m	FTP 24 AWG	20,40 USD
	725.061.015	15 m	FTP 24 AWG	28,50 USD
	725.061.020	20 m	FTP 24 AWG	36,60 USD
	725.061.030	30 m	FTP 24 AWG	52,80 USD
CAT6 S FTP 26 AWG LSOH	725.061.040	40 m	FTP 24 AWG	69,00 USD

	725.062.001	1 m	CAT6A - S - FTP 26 AWG	5,95 USD
	725.062.002	2 m	CAT6A - S - FTP 26 AWG	7,80 USD
	725.062.003	3 m	CAT6A - S - FTP 26 AWG	9,60 USD
	725.062.005	5 m	CAT6A - S - FTP 26 AWG	13,20 USD
	725.062.007	7 m	CAT6A - S - FTP 26 AWG	16,80 USD
	725.062.008	8 m	CAT6A - S - FTP 26 AWG	15,60 USD
	725.062.010	10 m	CAT6A - S - FTP 26 AWG	22,50 USD
	725.062.015	15 m	CAT6A - S - FTP 26 AWG	31,50 USD
	725.062.020	20 m	CAT6A - S - FTP 26 AWG	40,50 USD
	725.062.030	30 m	CAT6A - S - FTP 26 AWG	58,50 USD
725.062.040	40 m	CAT6A - S - FTP 26 AWG	70,50 USD	



TEM RAY PRİZLERİ

Standart Sigorta Rayına Uygun Prizler

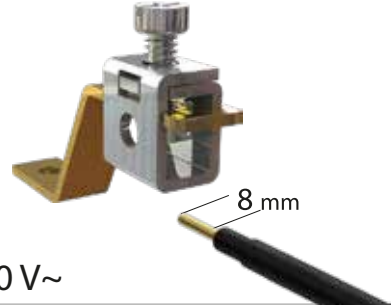

Ray Tipi Monofaze Prizler

2P+E

200-250 V~



217.216.171
Ray Tipi
Şebeke Prizi
Ledli
36,00 TL

217.216.170
Ray Tipi
Şebeke Prizi
Ledsiz
32,00 TL



217.316.171
Ray Tipi
UPS Prizi
Ledli
44,00 TL

217.316.170
Ray Tipi
UPS Prizi
Ledsiz
39,00 TL



217.416.171
Ray Tipi
Fransız Prizi
Ledli
40,00 TL

217.416.170
Ray Tipi
Fransız Prizi
Ledsiz
36,00 TL



Monofaze Prizler

16A

2P+E

200-250 V~

Tek Terminal IP44

Çift Terminal IP54



216.216.150
Şebeke Pano Prizi
17,00 TL



216.316.150
UPS Pano Prizi
20,00 TL



216.216.160
Şebeke Pano Prizi
18,00 TL



216.316.160
UPS Pano Prizi
21,00 TL



217.216.160
Fransız Pano Prizi
22,00 TL



440.116.160
IP44
Eğik Makine Prizi
26,00 TL



670.116.160
IP67 Kilitli Kapaklı
Eğik Makine Prizi
36,00 TL



440.116.150
IP44
Makine Prizi
26,00 TL



440.116.151
IP44 Dik Kasalı
Duvar Prizi
37,00 TL



440.116.152
IP44 Eğik Kasalı
Duvar Prizi
42,00 TL



440.116.153
IP44 Eğik Kasalı Duvar Prizi
+ Monofaze Pano Prizi
58,00 TL



Monofaze Kauçuk Fiş & Prizler

16A

2P+E

200-250 V~



215.116.200
Seyyar Priz
19,00 TL



215.116.301
Düz Uzun Fiş
15,50 TL



215.116.300 | 215.316.300
Şebeke Düz Fiş | UPS Düz Fiş
14,00 TL | 15,50 TL



215.116.320 | 215.316.320
Şebeke Eğik Fiş | UPS Eğik Fiş
18,00 TL | 19,50 TL



215.116.101
Tekli Priz
25,00 TL



215.116.102
İkili Grup Priz
44,00 TL



215.116.103
Üçlü Grup Priz
54,00 TL



215.116.104
Dörtlü Grup Priz
67,00 TL



Trifaze Fiş & Prizler 4x25 A

25A

380-415 V~



540.425.300 
Fiş
21,00 TL



540.425.200 
Seyyar Priz
34,00 TL



540.425.110 
Duvar Prizi Klemensli
39,00 TL



540.425.111 
1 Ad. Trifaze + 1 Ad. Monofaze
Grup Priz
70,00 TL



540.425.121 
2 Ad. Trifaze + 1 Ad. Monofaze
Grup Priz
102,00 TL



540.425.112 
1 Ad. Trifaze + 2 Ad. Monofaze
Grup Priz
95,00 TL



540.425.130 
3 Ad. Trifaze
Grup Priz
109,00 TL



540.425.150 
Pano Prizi
26,00 TL



540.425.151 
Dik Kasalı Duvar Prizi
37,00 TL



540.425.152 
Eğik Kasalı Duvar Prizi
42,00 TL



540.425.153 
Eğik Kasalı Duvar Prizi
+ Monofaze Pano Prizi
58,00 TL

Kauçuk Trifaze Prizler 3x16 A

16A

IP44

380-415 V~



544.316.300 
Fiş
38,00 TL



544.316.150 
Pano Prizi
31,00 TL



544.316.151 
Dik Kasalı Duvar Prizi
39,00 TL



544.316.152 
Eğik Kasalı Duvar Prizi
44,00 TL



544.316.153 
Eğik Kasalı Duvar Prizi
+ Monofaze Pano Prizi
65,00 TL

Kauçuk Trifaze Prizler 3x32 A

32A

IP44

380-415 V~



544.332.300 
Fiş
57,00 TL



544.332.150 
Pano Prizi
39,00 TL



544.332.151 
Dik Kasalı Duvar Prizi
45,00 TL



544.332.152 
Eğik Kasalı Duvar Prizi
51,00 TL



544.332.153 
Eğik Kasalı Duvar Prizi
+ Monofaze Pano Prizi
69,00 TL

3 Kutup

16A

4h

2P+E

IP44

110-130 V~



444.316.150
Pano Prizi
30,00 TL



444.316.151
Dik Kasalı Duvar Prizi
40,00 TL



444.316.152
Eğik Kasalı Duvar Prizi
49,00 TL



444.316.200
Seyyar Priz
34,00 TL



444.316.300
Fiş
30,00 TL

3 Kutup

16A

6h

2P+E

IP44

200-250 V~



446.316.150
Pano Prizi
28,00 TL



446.316.151
Dik Kasalı Duvar Prizi
38,00 TL



446.316.152
Eğik Kasalı Duvar Prizi
47,00 TL



446.316.153
Eğik Kasalı Duvar Prizi + Monofaze Priz
71,00 TL



446.316.200
Seyyar Priz
32,00 TL



446.316.300
Fiş
28,00 TL

3 Kutup

32A

6h

2P+E

200-250 V~



446.332.150
IP44 Pano Prizi
43,00 TL



446.332.151
IP44 Dik Kasalı Duvar Prizi
64,00 TL



446.332.400
IP44 Eğik Duvar Prizi
64,00 TL



446.332.200
IP44 Seyyar Priz
54,00 TL



446.332.300
IP44 Fiş
47,00 TL



676.332.150
IP67 Kilitli Kapaklı Pano Prizi
52,00 TL



676.332.151
Kilitli Kapaklı Dik Kasalı Duvar Prizi
72,00 TL



676.332.300
Kilitli Fiş
54,00 TL

4 Kutup

16A

6h

3P+E

380-415 V~



446.416.150 
IP44 Pano Prizi
38,00 TL



446.416.160 
IP44 Pano Prizi
46,00 TL



446.416.151 
IP44 Dik Kasalı Duvar Prizi
50,00 TL



446.416.152 
IP44 Eğik Kasalı Duvar Prizi
58,00 TL



446.416.153 
IP44 Eğik Kasalı Duvar Prizi
+ Monofaze Priz
80,00 TL



446.416.200 
IP44 Seyyar Priz
48,00 TL



446.416.300 
IP44 Fiş
42,00 TL



676.416.160 
IP67 Kilitli Kapaklı Pano Prizi
55,00 TL



676.416.161 
Kilitli Kapaklı Dik Kasalı Duvar Prizi
79,00 TL



676.416.200 
Kilitli Kapaklı Seyyar Priz
52,00 TL



676.416.300 
Kilitli Fiş
46,00 TL

4 Kutup

32A

6h

3P+E

380-415 V~



446.432.150 
IP44 Pano Prizi
56,00 TL



446.432.151 
IP44 Dik Kasalı Duvar Prizi
77,00 TL



446.432.400 
IP44 Eğik Duvar Prizi
67,00 TL



446.432.200 
IP44 Seyyar Priz
62,00 TL



446.432.300 
IP44 Fiş
53,00 TL



446.432.330 
IP44 Makine
Fişi
38,00 TL



446.432.331 
IP44 Düz
Kasalı Makine Fişi
50,00 TL



446.432.332 
IP44 Eğik Kasalı
Makine Fişi
56,00 TL



446.432.333 
IP44 Eğik Kasalı Makine Fişi
+ Monofaze Pano Prizi
78,00 TL

4 Kutup

32A

6h

3P+E

380-415 V~



676.432.150 12
IP67 Kilitli Kapaklı Pano Prizi
62,00 TL



676.432.151 6
IP67 Kilitli Kapaklı Dik Kasalı Duvar Prizi
82,00 TL



676.432.300 12
IP67 Kilitli Fiş
62,00 TL

4 Kutup

63A

6h

3P+E

380-415 V~



446.463.150 6
IP44 Pano Prizi
163,00 TL



446.463.200 6
IP44 Seyyar Priz
220,00 TL



446.463.300 6
IP44 Fiş
156,00 TL



676.463.150 6
IP67 Kilitli Kapaklı Pano Prizi
195,00 TL



676.463.200 4
IP67 Kilitli Seyyar Priz
264,00 TL



676.463.300 4
IP67 Kilitli Fiş
187,00 TL

5 Kutup

16A

6h

3P+N+E

380-415 V~



446.516.150 12
IP44 Pano Prizi
44,00 TL



446.516.151 12
IP44 Dik Kasalı Duvar Prizi
53,00 TL



446.516.152 4
IP44 Eğik Kasalı Duvar Prizi
61,00 TL



446.516.153 4
IP44 Eğik Kasalı Duvar Prizi
+ Monofaze Priz
86,00 TL



446.516.400 12
IP44 Eğik Duvar Prizi
46,00 TL



446.516.200 12
IP44 Seyyar Priz
39,00 TL



446.516.300 12
IP44 Fiş
37,00 TL



446.516.320 12
IP44 Eğik Fiş
45,00 TL

5 Kutup

16A

6h

3P+N+E

380-415 V~



446.516.330 
IP44 Makine Fişi
35,00 TL



446.516.331 
IP44 Düz Kasalı Makine Fişi
45,00 TL



446.516.332 
IP44 Eğik Kasalı Makine Fişi
53,00 TL

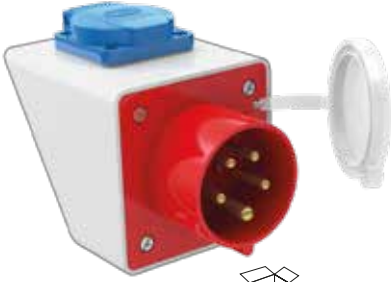

446.516.333 
IP44 Eğik Kasalı Makine Fişi
+ Monofaze Pano Prizi
71,00 TL



676.516.150 
IP67 Kilitli Kapaklı Pano Prizi
47,00 TL



676.516.151 
Kilitli Kapaklı Dik Kasalı Duvar Prizi
63,00 TL



676.516.152 
Kilitli Kapaklı Eğik Kasalı
Duvar Prizi
87,00 TL



676.516.153 
Kilitli Kapaklı Eğik Kasalı Duvar Prizi
+ Monofaze Pano Prizi
95,00 TL



676.516.300 
Kilitli Fiş
43,00 TL

5 Kutup

32A

6h

3P+N+E

380-415 V~



446.532.150 
IP44 Pano Prizi
64,00 TL



446.532.151 
IP44 Dik Kasalı Duvar Prizi
75,00 TL



446.532.200 
IP44 Seyyar Priz
74,00 TL



446.532.300 
IP44 Fiş
54,00 TL

5 Kutup

32A

6h

3P+N+E

380-415 V~



446.532.330 
IP44 Makine Fişi
55,00 TL



446.532.331 
IP44 Düz Kasalı Makine Fişi
65,00 TL



446.532.332 
IP44 Eğik Kasalı Makine Fişi
88,00 TL

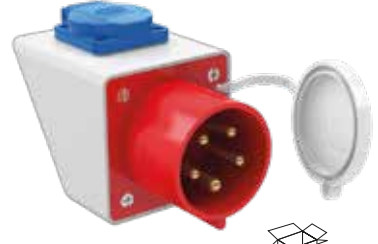

446.532.333 
IP44 Eğik Kasalı Makine Fişi
+ Monofaze Pano Prizi
110,00 TL



676.532.150 
IP67 Kilitli Kapaklı Pano Prizi
69,00 TL



676.532.151 
Kilitli Kapaklı Dik Kasalı Duvar Prizi
81,00 TL



676.532.300 
Kilitli Fiş
68,00 TL

5 Kutup

63A

6h

3P+N+E

380-415 V~



446.563.150 
IP44 Pano Prizi
203,00 TL



446.563.200 
IP44 Seyyar Priz
275,00 TL



446.563.300 
IP44 Fiş
195,00 TL



676.563.150 
IP67 Kilitli Kapaklı Pano Prizi
234,00 TL



676.563.200 
IP67 Kilitli Seyyar Priz
308,00 TL



676.563.300 
IP67 Kilitli Fiş
225,00 TL

Seyyar 3'lü Çoklayıcı Prizler (Fiş Girişli)

IP44

6h

50/60 Hz.



Ürün Kodu	Kutup	I(A)	Volt	Renk		Fiyat
1344.316.333.0	2P+E	16	200-250	◆	2	350,00 TL
1344.332.333.0	2P+E	32	200-250	◆	4	650,00 TL
1344.416.333.0	3P+E	16	380-415	◆	2	380,00 TL
1344.432.333.0	3P+E	32	380-415	◆	2	650,00 TL
1344.516.333.0	3P+N+E	16	380-415	◆	2	470,00 TL
1344.532.333.0	3P+N+E	32	380-415	◆	2	700,00 TL

Seyyar 3'lü Çoklayıcı Prizler (Fiş Girişli)

IP67

6h

50/60 Hz.



Ürün Kodu	Kutup	I(A)	Volt	Renk		Fiyat
1367.316.333.0	2P+E	16	200-250	◆	2	520,00 TL
1367.332.333.0	2P+E	32	200-250	◆	4	650,00 TL
1367.416.333.0	3P+E	16	380-415	◆	2	420,00 TL
1367.432.333.0	3P+E	32	380-415	◆	2	750,00 TL
1367.516.333.0	3P+N+E	16	380-415	◆	2	530,00 TL
1367.532.333.0	3P+N+E	32	380-415	◆	2	720,00 TL

Seyyar 3'lü Çoklayıcı Prizler (Rekor Girişli)

IP44

6h

50/60 Hz.



Ürün Kodu	Kutup	I(A)	Volt	Renk		Fiyat
1344.316.333.1	2P+E	16	200-250	◆	2	360,00 TL
1344.332.333.1	2P+E	32	200-250	◆	4	480,00 TL
1344.416.333.1	3P+E	16	380-415	◆	2	400,00 TL
1344.432.333.1	3P+E	32	380-415	◆	2	520,00 TL
1344.516.333.1	3P+N+E	16	380-415	◆	4	420,00 TL
1344.532.333.1	3P+N+E	32	380-415	◆	4	550,00 TL

Seyyar 3'lü Çoklayıcı Prizler (Rekor Girişli)

IP67

6h

50/60 Hz.



Ürün Kodu	Kutup	I(A)	Volt	Renk		Fiyat
1367.316.333.1	2P+E	16	200-250	◆	2	450,00 TL
1367.332.333.1	2P+E	32	200-250	◆	4	560,00 TL
1367.416.333.1	3P+E	16	380-415	◆	2	430,00 TL
1367.432.333.1	3P+E	32	380-415	◆	2	580,00 TL
1367.516.333.1	3P+N+E	16	380-415	◆	4	490,00 TL
1367.532.333.1	3P+N+E	32	380-415	◆	4	630,00 TL

Dik Pano Prizleri (75x75)

IP44

6h

50/60 Hz.



Ürün Kodu	Kutup	I(A)	Volt	Renk		Fiyat
446.316.180	2P+E	16	200-250	◆	10	39,00 TL
446.332.180	2P+E	32	200-250	◆	5	56,00 TL
446.416.180	3P+E	16	380-415	◆	10	46,00 TL
446.432.180	3P+E	32	380-415	◆	5	66,00 TL
446.516.180	3P+N+E	16	380-415	◆	8	56,00 TL
446.532.180	3P+N+E	32	380-415	◆	5	72,00 TL

Eğik Pano Prizleri



Ürün Kodu	Kutup	I(A)	Volt	Renk		Fiyat
446.316.190	2P+E	16	200-250	◆	10	39,00 TL
446.332.190	2P+E	32	200-250	◆	5	56,00 TL
446.416.190	3P+E	16	380-415	◆	10	46,00 TL
446.432.190	3P+E	32	380-415	◆	5	66,00 TL
446.516.190	3P+N+E	16	380-415	◆	8	56,00 TL
446.532.190	3P+N+E	32	380-415	◆	5	72,00 TL

Seyyar Prizler



Ürün Kodu	Kutup	I(A)	Volt	Renk		Fiyat
446.316.240	2P+E	16	200-250	◆	10	40,00 TL
446.332.240	2P+E	32	200-250	◆	4	60,00 TL
446.416.240	3P+E	16	380-415	◆	10	50,00 TL
446.432.240	3P+E	32	380-415	◆	4	68,00 TL
446.516.240	3P+N+E	16	380-415	◆	5	56,00 TL
446.532.240	3P+N+E	32	380-415	◆	3	70,00 TL

Seyyar Fişler



Ürün Kodu	Kutup	I(A)	Volt	Renk		Fiyat
446.316.340	2P+E	16	200-250	◆	10	30,00 TL
446.332.340	2P+E	32	200-250	◆	5	48,00 TL
446.416.340	3P+E	16	380-415	◆	10	38,00 TL
446.432.340	3P+E	32	380-415	◆	5	54,00 TL
446.516.340	3P+N+E	16	380-415	◆	8	44,00 TL
446.532.340	3P+N+E	32	380-415	◆	4	58,00 TL

Eğik Duvar Prizleri



Ürün Kodu	Kutup	I(A)	Volt	Renk		Fiyat
446.316.410	2P+E	16	200-250	◆	3	72,00 TL
446.332.410	2P+E	32	200-250	◆	2	88,00 TL
446.416.410	3P+E	16	380-415	◆	3	76,00 TL
446.432.410	3P+E	32	380-415	◆	2	98,00 TL
446.516.410	3P+N+E	16	380-415	◆	3	84,00 TL
446.532.410	3P+N+E	32	380-415	◆	2	110,00 TL

Dik Pano Prizleri (75x75)

IP67

6h

50/60 Hz.



Ürün Kodu	Kutup	I(A)	Volt	Renk		Fiyat
676.316.180	2P+E	16	200-250	◆	8	66,00 TL
676.332.180	2P+E	32	200-250	◆	5	82,00 TL
676.416.180	3P+E	16	380-415	◆	8	76,00 TL
676.432.180	3P+E	32	380-415	◆	5	92,00 TL
676.516.180	3P+N+E	16	380-415	◆	8	80,00 TL
676.532.180	3P+N+E	32	380-415	◆	5	98,00 TL

Eğik Pano Prizleri



Ürün Kodu	Kutup	I(A)	Volt	Renk		Fiyat
676.316.190	2P+E	16	200-250	◆	10	66,00 TL
676.332.190	2P+E	32	200-250	◆	5	82,00 TL
676.416.190	3P+E	16	380-415	◆	8	76,00 TL
676.432.190	3P+E	32	380-415	◆	5	92,00 TL
676.516.190	3P+N+E	16	380-415	◆	8	80,00 TL
676.532.190	3P+N+E	32	380-415	◆	5	98,00 TL

Seyyar Prizler



Ürün Kodu	Kutup	I(A)	Volt	Renk		Fiyat
676.316.240	2P+E	16	200-250	◆	10	66,00 TL
676.332.240	2P+E	32	200-250	◆	4	102,00 TL
676.416.240	3P+E	16	380-415	◆	8	78,00 TL
676.432.240	3P+E	32	380-415	◆	4	110,00 TL
676.516.240	3P+N+E	16	380-415	◆	4	86,00 TL
676.532.240	3P+N+E	32	380-415	◆	3	120,00 TL

Seyyar Fişler



Ürün Kodu	Kutup	I(A)	Volt	Renk		Fiyat
676.316.340	2P+E	16	200-250	◆	10	50,00 TL
676.332.340	2P+E	32	200-250	◆	4	78,00 TL
676.416.340	3P+E	16	380-415	◆	8	62,00 TL
676.432.340	3P+E	32	380-415	◆	4	89,00 TL
676.516.340	3P+N+E	16	380-415	◆	6	78,00 TL
676.532.340	3P+N+E	32	380-415	◆	3	102,00 TL

Eğik Duvar Prizleri



Ürün Kodu	Kutup	I(A)	Volt	Renk		Fiyat
676.316.410	2P+E	16	200-250	◆	3	103,00 TL
676.332.410	2P+E	32	200-250	◆	2	117,00 TL
676.416.410	3P+E	16	380-415	◆	3	105,00 TL
676.432.410	3P+E	32	380-415	◆	2	128,00 TL
676.516.410	3P+N+E	16	380-415	◆	3	115,00 TL
676.532.410	3P+N+E	32	380-415	◆	2	135,00 TL

İçten Kilitli Şalterli Pano Prizi (Yatay Tip)

IP44

6h

50/60 Hz.



Ürün Kodu	Kutup	I(A)	Volt	Renk		Fiyat
1444.316.15	2P+E	16	200-250	◆	1	278,00 TL
1444.332.15	2P+E	32	200-250	◆	1	350,00 TL
1444.416.15	3P+E	16	380-415	◆	1	330,00 TL
1444.432.15	3P+E	32	380-415	◆	1	410,00 TL
1444.516.15	3P+N+E	16	380-415	◆	1	380,00 TL
1444.532.15	3P+N+E	32	380-415	◆	1	428,00 TL

İçten Kilitli Şalterli Pano Prizi (Yatay Tip)

IP67

6h

50/60 Hz.



Ürün Kodu	Kutup	I(A)	Volt	Renk		Fiyat
1467.316.15	2P+E	16	200-250	◆	1	340,00 TL
1467.332.15	2P+E	32	200-250	◆	1	440,00 TL
1467.416.15	3P+E	16	380-415	◆	1	400,00 TL
1467.432.15	3P+E	32	380-415	◆	1	460,00 TL
1467.516.15	3P+N+E	16	380-415	◆	1	440,00 TL
1467.532.15	3P+N+E	32	380-415	◆	1	520,00 TL

İçten Kilitli Şalterli Duvar Prizi (Yatay Tip)

IP44

6h

50/60 Hz.



Ürün Kodu	Kutup	I(A)	Volt	Renk		Fiyat
1444.316.10	2P+E	16	200-250	◆	1	340,00 TL
1444.332.10	2P+E	32	200-250	◆	1	390,00 TL
1444.416.10	3P+E	16	380-415	◆	1	360,00 TL
1444.432.10	3P+E	32	380-415	◆	1	420,00 TL
1444.516.10	3P+N+E	16	380-415	◆	1	410,00 TL
1444.532.10	3P+N+E	32	380-415	◆	1	440,00 TL

İçten Kilitli Şalterli Duvar Prizi (Yatay Tip)

IP67

6h

50/60 Hz.



Ürün Kodu	Kutup	I(A)	Volt	Renk		Fiyat
1467.316.10	2P+E	16	200-250	◆	1	410,00 TL
1467.332.10	2P+E	32	200-250	◆	1	490,00 TL
1467.416.10	3P+E	16	380-415	◆	1	430,00 TL
1467.432.10	3P+E	32	380-415	◆	1	520,00 TL
1467.516.10	3P+N+E	16	380-415	◆	1	480,00 TL
1467.532.10	3P+N+E	32	380-415	◆	1	540,00 TL

İçten Kilitli Şalterli Pano Prizi (Dikey Tip)

IP44

6h

50/60 Hz.



Ürün Kodu	Kutup	I(A)	Volt	Renk		Fiyat
1944.316.15	2P+E	16	200-250	◆	1	290,00 TL
1944.332.15	2P+E	32	200-250	◆	1	360,00 TL
1944.416.15	3P+E	16	380-415	◆	1	320,00 TL
1944.432.15	3P+E	32	380-415	◆	1	420,00 TL
1944.516.15	3P+N+E	16	380-415	◆	1	370,00 TL
1944.532.15	3P+N+E	32	380-415	◆	1	420,00 TL

İçten Kilitli Şalterli Pano Prizi (Dikey Tip)

IP67

6h

50/60 Hz.



Ürün Kodu	Kutup	I(A)	Volt	Renk		Fiyat
1967.316.15	2P+E	16	200-250	◆	1	360,00 TL
1967.332.15	2P+E	32	200-250	◆	1	440,00 TL
1967.416.15	3P+E	16	380-415	◆	1	410,00 TL
1967.432.15	3P+E	32	380-415	◆	1	480,00 TL
1967.516.15	3P+N+E	16	380-415	◆	1	445,00 TL
1967.532.15	3P+N+E	32	380-415	◆	1	520,00 TL

İçten Kilitli Şalterli Duvar Prizi (Dikey Tip)

IP44

6h

50/60 Hz.



Ürün Kodu	Kutup	I(A)	Volt	Renk		Fiyat
1944.316.10	2P+E	16	200-250	◆	1	350,00 TL
1944.332.10	2P+E	32	200-250	◆	1	418,00 TL
1944.416.10	3P+E	16	380-415	◆	1	370,00 TL
1944.432.10	3P+E	32	380-415	◆	1	420,00 TL
1944.516.10	3P+N+E	16	380-415	◆	1	416,00 TL
1944.532.10	3P+N+E	32	380-415	◆	1	446,00 TL

İçten Kilitli Şalterli Duvar Prizi (Dikey Tip)

IP67

6h

50/60 Hz.



Ürün Kodu	Kutup	I(A)	Volt	Renk		Fiyat
1967.316.10	2P+E	16	200-250	◆	1	420,00 TL
1967.332.10	2P+E	32	200-250	◆	1	490,00 TL
1967.416.10	3P+E	16	380-415	◆	1	440,00 TL
1967.432.10	3P+E	32	380-415	◆	1	520,00 TL
1967.516.10	3P+N+E	16	380-415	◆	1	490,00 TL
1967.532.10	3P+N+E	32	380-415	◆	1	540,00 TL

İçten Kilitli Şalterli Sigortalı Pano Prizi

IP44

6h

50/60 Hz.



Ürün Kodu	Kutup	I(A)	Volt	Renk		Fiyat
1644.316.15	2P+E	16	200-250	◆	1	440,00 TL
1644.332.15	2P+E	32	200-250	◆	1	560,00 TL
1644.416.15	3P+E	16	380-415	◆	1	480,00 TL
1644.432.15	3P+E	32	380-415	◆	1	620,00 TL
1644.516.15	3P+N+E	16	380-415	◆	1	520,00 TL
1644.532.15	3P+N+E	32	380-415	◆	1	515,00 TL

İçten Kilitli Şalterli Sigortalı Pano Prizi

IP67

6h

50/60 Hz.



Ürün Kodu	Kutup	I(A)	Volt	Renk		Fiyat
1667.316.15	2P+E	16	200-250	◆	1	460,00 TL
1667.332.15	2P+E	32	200-250	◆	1	580,00 TL
1667.416.15	3P+E	16	380-415	◆	1	500,00 TL
1667.432.15	3P+E	32	380-415	◆	1	640,00 TL
1667.516.15	3P+N+E	16	380-415	◆	1	538,00 TL
1667.532.15	3P+N+E	32	380-415	◆	1	670,00 TL

İçten Kilitli Şalterli Sigortalı Duvar Prizi

IP44

6h

50/60 Hz.



Ürün Kodu	Kutup	I(A)	Volt	Renk		Fiyat
1644.316.10	2P+E	16	200-250	◆	1	495,00 TL
1644.332.10	2P+E	32	200-250	◆	1	610,00 TL
1644.416.10	3P+E	16	380-415	◆	1	542,00 TL
1644.432.10	3P+E	32	380-415	◆	1	672,00 TL
1644.516.10	3P+N+E	16	380-415	◆	1	580,00 TL
1644.532.10	3P+N+E	32	380-415	◆	1	710,00 TL

İçten Kilitli Şalterli Sigortalı Duvar Prizi

IP67

6h

50/60 Hz.



Ürün Kodu	Kutup	I(A)	Volt	Renk		Fiyat
1667.316.10	2P+E	16	200-250	◆	1	520,00 TL
1667.332.10	2P+E	32	200-250	◆	1	626,00 TL
1667.416.10	3P+E	16	380-415	◆	1	560,00 TL
1667.432.10	3P+E	32	380-415	◆	1	690,00 TL
1667.516.10	3P+N+E	16	380-415	◆	1	600,00 TL
1667.532.10	3P+N+E	32	380-415	◆	1	730,00 TL

260x350mm Priz Montajlı Sigortalı Kombinasyon Kutuları (12 Sigorta Kapasiteli)

HALOJEN FREE

Ürün Kodu	IP44 Kombinasyon Kutuları		Fiyat
351.0012.0000.000	260x350x120mm IP44 Boş Kombinasyon Kutusu	1	201,00 TL
351.4160.1160.224	2 Ad. IP44 4x16A CEE + 2 Ad. IP44 1x16A Ön + 4 Ad. IP44 1x16A Yan	1	373,00 TL
351.0000.4160.042	4 Ad. IP44 4x16A CEE Ön + 2 Ad. 1x16 Yan	1	387,00 TL
351.0000.3163.044	4 Ad. IP44 3x16A Ön + 4 Ad. 1x16 Yan	1	393,00 TL
351.3323.3163.224	2 Ad. IP44 3x32A Ön + 2 Ad. IP44 3x16 Ön + 4 Ad. 1x16A Yan	1	409,00 TL
351.0000.3323.044	4 Ad. IP44 3x32A Ön + 4 Ad. 1x16A Yan	1	425,00 TL
351.4320.4250.222	2 Ad. IP44 4x32A CEE Ön + 2 Ad. IP44 4x25A Ön + 2 Ad. 1x16A Yan	1	399,00 TL
351.0000.4250.044	4 Ad. IP44 4x25A Ön + 4 Ad. 1x16A Yan	1	373,00 TL
351.0000.4320.046	4 Ad. IP44 4x32A CEE Ön + 6 Ad. 1x16A Yan	1	527,00 TL
351.0000.4321.044	4 Ad. IP67 4x32A CEE Ön + 4 Ad. 1x16A Yan	1	517,00 TL
351.4631.4321.222	2 Ad. IP67 4x63A CEE Ön + 2 Ad. IP67 4x32A CEE Ön + 2 Ad. 1x16 Yan	1	750,00 TL
351.0000.4630.028	2 Ad. IP44 4x63A CEE Ön + 4 Ad. 1x16A Ön + 4 Ad. 1x16 Yan	1	663,00 TL
351.5320.5160.222	2 Ad. IP44 5x32A CEE Ön + 2 Ad. IP44 5x16A CEE Ön + 2 Ad. 1x16 Yan	1	451,00 TL
351.0000.5321.046	4 Ad. IP67 5x32A CEE Ön + 6 Ad. 1x16A Yan	1	579,00 TL
351.5631.5321.222	2 Ad. IP67 5x63A CEE Ön + 2 Ad. IP67 5x32A CEE Ön + 2 Ad. 1x16A Yan	1	841,00 TL

Ürün Kodu	IP67 Kombinasyon Kutuları		Fiyat
451.0012.0000.000	260x350x120mm IP67 Boş Kombinasyon Kutusu	1	210,00 TL
451.4160.1160.224	2 Ad. IP44 4x16A CEE + 2 Ad. IP44 1x16A Ön + 4 Ad. IP44 1x16A Yan	1	354,00 TL
451.0000.4160.042	4 Ad. IP44 4x16A CEE Ön + 2 Ad. 1x16 Yan	1	396,00 TL
451.0000.3163.044	4 Ad. IP44 3x16A Ön + 4 Ad. 1x16 Yan	1	402,00 TL
451.3323.3163.224	2 Ad. IP44 3x32A Ön + 2 Ad. IP44 3x16 Ön + 4 Ad. 1x16A Yan	1	418,00 TL
451.0000.3323.044	4 Ad. IP44 3x32A Ön + 4 Ad. 1x16A Yan	1	434,00 TL
451.4320.4250.222	2 Ad. IP44 4x32A CEE Ön + 2 Ad. IP44 4x25A Ön + 2 Ad. 1x16A Yan	1	408,00 TL
451.0000.4250.044	4 Ad. IP44 4x25A Ön + 4 Ad. 1x16A Yan	1	382,00 TL
451.0000.4320.046	4 Ad. IP44 4x32A CEE Ön + 6 Ad. 1x16A Yan	1	536,00 TL
451.0000.4321.044	4 Ad. IP67 4x32A CEE Ön + 4 Ad. 1x16A Yan	1	526,00 TL
451.4631.4321.222	2 Ad. IP67 4x63A CEE Ön + 2 Ad. IP67 4x32A CEE Ön + 2 Ad. 1x16 Yan	1	759,00 TL
451.0000.4630.028	2 Ad. IP44 4x63A CEE Ön + 4 Ad. 1x16A Ön + 4 Ad. 1x16 Yan	1	672,00 TL
451.5320.5160.222	2 Ad. IP44 5x32A CEE Ön + 2 Ad. IP44 5x16A CEE Ön + 2 Ad. 1x16 Yan	1	460,00 TL
451.0000.5321.046	4 Ad. IP67 5x32A CEE Ön + 6 Ad. 1x16A Yan	1	588,00 TL
451.5631.5321.222	2 Ad. IP67 5x63A CEE Ön + 2 Ad. IP67 5x32A CEE Ön + 2 Ad. 1x16A Yan	1	850,00 TL



451.0012.0000.000



451.0000.4160.028



451.4160.3160.224





451.5320.5160.224



451.4321.5321.220

**210x280mm Priz Montajlı Sigortalı Kombinasyon Kutuları
(8 Sigorta Kapasiteli - Halojen Free)**

Ürün Kodu	IP44 Kombinasyon Kutuları		Fiyat
352.0008.0000.000	210x280x100mm IP44 Boş Kombinasyon Kutusu	1	118,00 TL
352.0000.4160.011	1 Ad. IP44 4x16A CEE Ön + 1 Ad. 1x16A Ön	1	173,00 TL
352.0000.4160.012	1 Ad. IP44 4x16A CEE Ön + 2 Ad. 1x16A Ön	1	190,00 TL
352.0000.4160.022	2 Ad. IP44 4x16A CEE Ön + 2 Ad. 1x16A Yan	1	228,00 TL
352.0000.4250.021	2 Ad. IP44 4x25A Ön + 1 Ad. 1x16A Yan	1	187,00 TL
352.0000.4250.022	2 Ad. IP44 4x25A Ön + 2 Ad. 1x16A Yan	1	204,00 TL
352.0000.4320.022	2 Ad. IP44 4x32A CEE Ön + 2 Ad. 1x16A Yan	1	264,00 TL
352.0000.4321.024	2 Ad. IP67 4x32A CEE Ön + 4 Ad. 1x16A Yan	1	310,00 TL
352.0000.5160.022	2 Ad. IP44 5x16A CEE Ön + 2 Ad. 1x16A Yan	1	240,00 TL
352.0000.5320.012	1 Ad. IP44 5x32A CEE Ön + 2 Ad. 1x16A Ön	1	216,00 TL
352.0000.5320.022	2 Ad. IP44 5x32A CEE Ön + 2 Ad. 1x16A Yan	1	280,00 TL
352.0000.5321.014	1 Ad. IP67 5x32A CEE Ön + 2 Ad. 1x16A Ön + 2 Ad. 1x16A Yan	1	255,00 TL
352.0000.3163.022	2 Ad. IP44 3x16A Ön + 2 Ad. 1x16A Yan	1	214,00 TL
352.3323.3163.112	1 Ad. IP44 3x32A Ön + 1 Ad. IP44 3x16A Ön + 2 Ad. 1x16A Yan	1	222,00 TL
352.0000.3323.022	2 Ad. IP44 3x32A CEE Ön + 2 Ad. 1x16A Yan	1	230,00 TL

Ürün Kodu	IP67 Kombinasyon Kutuları		Fiyat
452.0008.0000.000	210x280x100mm IP67 Boş Kombinasyon Kutusu	1	126,00 TL
452.0000.4160.011	1 Ad. IP44 4x16A CEE Ön + 1 Ad. 1x16A Ön	1	181,00 TL
452.0000.4160.012	1 Ad. IP44 4x16A CEE Ön + 2 Ad. 1x16A Ön	1	198,00 TL
452.0000.4160.022	2 Ad. IP44 4x16A CEE Ön + 2 Ad. 1x16A Yan	1	236,00 TL
452.0000.4250.021	2 Ad. IP44 4x25A Ön + 1 Ad. 1x16A Yan	1	195,00 TL
452.0000.4250.022	2 Ad. IP44 4x25A Ön + 2 Ad. 1x16A Yan	1	212,00 TL
452.0000.4320.022	2 Ad. IP44 4x32A CEE Ön + 2 Ad. 1x16A Yan	1	272,00 TL
452.0000.4321.024	2 Ad. IP67 4x32A CEE Ön + 4 Ad. 1x16A Yan	1	318,00 TL
452.0000.5160.022	2 Ad. IP44 5x16A CEE Ön + 2 Ad. 1x16A Yan	1	248,00 TL
452.0000.5320.012	1 Ad. IP44 5x32A CEE Ön + 2 Ad. 1x16A Ön	1	224,00 TL
452.0000.5320.022	2 Ad. IP44 5x32A CEE Ön + 2 Ad. 1x16A Yan	1	288,00 TL
452.0000.5321.014	1 Ad. IP67 5x32A CEE Ön + 2 Ad. 1x16A Ön + 2 Ad. 1x16A Yan	1	263,00 TL
452.0000.3163.022	2 Ad. IP44 3x16A Ön + 2 Ad. 1x16A Yan	1	222,00 TL
452.3323.3163.112	1 Ad. IP44 3x32A Ön + 1 Ad. IP44 3x16A Ön + 2 Ad. 1x16A Yan	1	230,00 TL
452.0000.3323.022	2 Ad. IP44 3x32A CEE Ön + 2 Ad. 1x16A Yan	1	238,00 TL



452.0008.0000.000



452.0000.3160.022



452.0000.4160.012



452.0000.4320.022



452.0000.5321.020

**135x250mm Priz Montajlı Sigortalı Kombinasyon Kutuları
(6 Sigorta Kapasiteli - Halojen Free)**

HALOJEN FREE

Ürün Kodu	IP44 Kombinasyon Kutuları		Fiyat
363.0006.0000.000	135x250x120mm IP44 Boş Kombinasyon Kutusu		2 85,00 TL
363.0000.3163.012	1 Ad. IP44 3x16A Ön + 2 Ad. 1x16A Yan		2 150,00 TL
363.0000.3323.012	1 Ad. IP44 3x32A Ön + 2 Ad. 1x16A Yan		2 158,00 TL
363.0000.4250.012	1 Ad. IP44 4x25A Ön + 2 Ad. 1x16A Yan		2 145,00 TL
363.0000.4160.012	1 Ad. IP44 4x16A CEE Ön + 2 Ad. 1x16A Yan		2 157,00 TL
363.0000.4320.012	1 Ad. IP44 4x32A CEE Ön + 2 Ad. 1x16A Yan		2 175,00 TL
363.0000.5160.012	1 Ad. IP44 5x16A CEE Ön + 2 Ad. 1x16A Yan		2 163,00 TL
363.0000.5320.012	1 Ad. IP44 5x32A CEE Ön + 2 Ad. 1x16A Yan		2 183,00 TL

363.0000.0000.000

Ürün Kodu	IP67 Kombinasyon Kutuları		Fiyat
463.0006.0000.000	135x250x120mm IP67 Boş Kombinasyon Kutusu		2 89,00 TL
463.0000.3163.012	1 Ad. IP44 3x16A Ön + 2 Ad. 1x16A Yan		2 154,00 TL
463.0000.3323.012	1 Ad. IP44 3x32A Ön + 2 Ad. 1x16A Yan		2 162,00 TL
463.0000.4250.012	1 Ad. IP44 4x25A Ön + 2 Ad. 1x16A Yan		2 149,00 TL
463.0000.4160.012	1 Ad. IP44 4x16A CEE Ön + 2 Ad. 1x16A Yan		2 161,00 TL
463.0000.4320.012	1 Ad. IP44 4x32A CEE Ön + 2 Ad. 1x16A Yan		2 179,00 TL
463.0000.5160.012	1 Ad. IP44 5x16A CEE Ön + 2 Ad. 1x16A Yan		2 167,00 TL
463.0000.5320.012	1 Ad. IP44 5x32A CEE Ön + 2 Ad. 1x16A Yan		2 187,00 TL

463.0000.3321.010

**113x210mm Priz Montajlı Sigortalı Kombinasyon Kutuları
(4 Sigorta Kapasiteli - Halojen Free)**

HALOJEN FREE

Ürün Kodu	IP44 Kombinasyon Kutuları		Fiyat
353.0004.0000.000	113x210x90mm IP44 Boş Kombinasyon Kutusu		3 65,00 TL
353.0000.3163.012	1 Ad. IP44 3x16A Ön + 2 Ad. 1x16A Yan		3 130,00 TL
353.0000.3323.012	1 Ad. IP44 3x32A Ön + 2 Ad. 1x16A Yan		3 138,00 TL
353.0000.4250.012	1 Ad. IP44 4x25A Ön + 2 Ad. 1x16A Yan		3 125,00 TL
353.0000.4160.012	1 Ad. 1P44 4x16A CEE Ön + 2 Ad. 1x16A Yan		3 137,00 TL
353.0000.4320.012	1 Ad. 1P44 4x32A CEE Ön + 2 Ad. 1x16A Yan		3 155,00 TL
353.0000.5160.012	1 Ad. 1P44 5x16A CEE Ön + 2 Ad. 1x16A Yan		3 143,00 TL
353.0000.5320.012	1 Ad. 1P44 5x32A CEE Ön + 2 Ad. 1x16A Yan		3 163,00 TL

353.0004.0000.000

Ürün Kodu	IP67 Kombinasyon Kutuları		Fiyat
453.0004.0000.000	113x210x90mm IP67 Boş Kombinasyon Kutusu		3 70,00 TL
453.0000.3163.012	1 Ad. IP44 3x16A Ön + 2 Ad. 1x16A Yan		3 135,00 TL
453.0000.3323.012	1 Ad. IP44 3x32A Ön + 2 Ad. 1x16A Yan		3 143,00 TL
453.0000.4250.012	1 Ad. IP44 4x25A Ön + 2 Ad. 1x16A Yan		3 130,00 TL
453.0000.4160.012	1 Ad. 1P44 4x16A CEE Ön + 2 Ad. 1x16A Yan		3 142,00 TL
453.0000.4320.012	1 Ad. 1P44 4x32A CEE Ön + 2 Ad. 1x16A Yan		3 160,00 TL
453.0000.5160.012	1 Ad. 1P44 5x16A CEE Ön + 2 Ad. 1x16A Yan		3 148,00 TL
453.0000.5320.012	1 Ad. 1P44 5x32A CEE Ön + 2 Ad. 1x16A Yan		3 168,00 TL

453.0000.4320.012

113x210mm Priz Montajlı Sigortalı Kombinasyon Kutuları (4 Sigorta Kapasiteli - Halojen Free)

HALOJEN FREE

Ürün Kodu	IP44 Kombinasyon Kutuları		Fiyat
454.0004.0000.000	113x210x90mm IP44 Boş Kombinasyon Kutusu	3	48,00 TL
454.0000.3320.012	1 Ad. IP44 3x32A CEE Ön + 2 Ad. 1x16A Yan	3	125,00 TL
454.0000.4160.012	1 Ad. IP44 4x16A CEE Ön + 2 Ad. IP44 1x16A Yan	3	120,00 TL
454.0000.3163.012	1 Ad. IP44 3x16A Ön + 2 Ad. 1x16A Yan	3	113,00 TL
454.0000.3323.012	1 Ad. IP44 3x32A Ön + 2 Ad. 1x16A Yan	3	121,00 TL



454.0004.0000.000



454.0000.3320.012



454.0000.4160.012



454.0000.5320.012



454.0000.4321.010

Priz Montajlı Sigortasız Kombinasyon Kutuları (Halojen Free)

HALOJEN FREE

Ürün Kodu	IP44 Kombinasyon Kutuları		Fiyat
355.0000.0000.000	210x280x100mm IP44 Boş Kombinasyon Kutusu	1	90,00 TL
355.4320.4160.224	2 Ad. IP44 4x32A CEE Ön + 2 Ad. IP44 4x16A CEE Ön + 4 Ad. 1x16A Yan	1	346,00 TL
355.4320.5160.220	2 Ad. IP44 4x32A CEE Ön + 2 Ad. IP44 5x16A CEE Ön	1	290,00 TL
356.0000.0000.000	113x113x73mm IP44 Boş Kombinasyon Kutusu	6	30,00 TL
356.0000.4160.012	1 Ad. IP44 4x16A CEE Ön + 2 Ad. 1x16A Yan	6	102,00 TL
356.0000.5160.012	1 Ad. IP44 5x16A CEE Ön + 2 Ad. 1x16A Yan	6	108,00 TL
357.0000.0000.000	210x113x73mm IP44 Boş Kombinasyon Kutusu	3	40,00 TL
357.0000.4320.022	2 Ad. IP44 4x32A CEE Ön + 2 Ad. 1x16A Yan	3	186,00 TL
357.0000.5320.022	2 Ad. IP44 5x32A CEE Ön + 2 Ad. 1x16A Yan	3	202,00 TL

Ürün Kodu	IP67 Kombinasyon Kutuları		Fiyat
455.0000.0000.000	210x280x100mm IP67 Boş Kombinasyon Kutusu	1	93,00 TL
455.4321.4161.224	2 Ad. IP67 4x32A CEE Ön + 2 Ad. IP67 4x16A CEE Ön + 4 Ad. 1x16A Yan	1	395,00 TL
455.4320.5160.220	2 Ad. IP44 4x32A CEE Ön + 2 Ad. IP44 5x16A CEE Ön	1	293,00 TL
456.0000.0000.000	113x113x73mm IP67 Boş Kombinasyon Kutusu	6	34,00 TL
456.0000.4160.012	1 Ad. IP44 4x16A CEE Ön + 2 Ad. 1x16A Yan	6	106,00 TL
456.0000.5160.012	1 Ad. IP44 5x16A CEE Ön + 2 Ad. 1x16A Yan	6	78,00 TL
457.0000.0000.000	210x113x73mm IP67 Boş Kombinasyon Kutusu	3	39,00 TL
457.0000.4320.022	2 Ad. IP44 4x32A CEE Ön + 2 Ad. 1x16A Yan	3	146,00 TL
457.0000.5320.022	2 Ad. IP44 5x32A CEE Ön + 2 Ad. 1x16A Yan	3	162,00 TL



455.0000.0000.000



455.0000.4160.028



455.4160.4320.224



457.0000.5320.022



456.0000.4160.012

Küçük Boy Taşıyıcı Ayak

Ürün Kodu	Açıklama	Ölçü (mm)		Fiyat
740.022.001	(351 - 451 - 352 - 452 - 361) Kombinasyonlar + (21x30 - 26x35 30x40) Panolar	310x610	1	186,00 TL



Büyük Boy Taşıyıcı Ayak

Ürün Kodu	Açıklama	Ölçü (mm)		Fiyat
740.022.002	(40x50 - 40x60 - 50x70) Panolar	510x1010	1	240,00 TL



Opak Kapaklı Termoplastik Buatlar

HALOJEN FREE

IP44 Ürün Kodu	IP67 Ürün Kodu	Dış Ölçü(mm)		IP44 Fiyat	IP67 Fiyat
344.041.101	-	85 x 85 x 41	24	11,00 TL	-
344.055.201	367.055.201	95 x 95 x 55	12	19,00 TL	24,00 TL
344.073.301	367.073.301	113 x 113 x 73	12	25,00 TL	33,00 TL
344.120.301	367.120.301	113 x 113 x 120	6	28,00 TL	38,00 TL
344.073.401	367.073.401	113 x 210 x 73	6	37,00 TL	47,00 TL
344.120.401	367.120.401	113 x 210 x 120	3	45,00 TL	56,00 TL
344.085.421	367.085.421	130 x 245 x 85	2	55,00 TL	66,00 TL
344.140.421	367.140.421	130 x 245 x 140	2	61,00 TL	72,00 TL
344.100.501	367.100.501	210 x 280 x 100	1	84,00 TL	99,00 TL
344.135.601	367.135.601	210 x 280 x 135	1	90,00 TL	105,00 TL
344.115.501	367.115.501	260 x 350 x 115	1	136,00 TL	160,00 TL
344.145.601	367.145.601	260 x 350 x 145	1	150,00 TL	175,00 TL
344.155.601	367.155.601	260 x 350 x 155	1	155,00 TL	180,00 TL
344.185.601	367.185.601	260 x 350 x 185	1	165,00 TL	198,00 TL



367.073.301



367.073.401



367.100.501



367.135.601



367.155.601

Şeffaf Kapaklı Termoplastik Buatlar

HALOJEN FREE

IP44 Ürün Kodu	IP67 Ürün Kodu	Dış Ölçü(mm)		IP44 Fiyat	IP67 Fiyat
344.055.202	367.055.202	95 x 95 x 55	12	24,00 TL	25,00 TL
344.073.302	367.073.302	113 x 113 x 73	12	30,00 TL	41,00 TL
344.120.302	367.120.302	113 x 113 x 120	6	38,00 TL	52,00 TL
344.073.402	367.073.402	113 x 210 x 73	6	44,00 TL	57,00 TL
344.120.402	367.120.402	113 x 210 x 120	3	65,00 TL	82,00 TL
344.085.422	367.085.422	130 x 245 x 85	2	68,00 TL	85,00 TL
344.140.422	367.140.422	130 x 245 x 140	2	72,00 TL	95,00 TL
344.100.502	367.100.502	210 x 280 x 100	1	112,00 TL	139,00 TL
344.135.602	367.135.602	210 x 280 x 135	1	120,00 TL	148,00 TL
344.115.502	367.115.502	260 x 350 x 115	1	182,00 TL	220,00 TL
344.145.602	367.145.602	260 x 350 x 145	1	195,00 TL	240,00 TL
344.155.602	367.155.602	260 x 350 x 155	1	210,00 TL	250,00 TL
344.185.602	367.185.602	260 x 350 x 185	1	225,00 TL	265,00 TL



367.073.302



367.073.402



367.100.502



367.135.602



367.155.602

Taban Saçlı

IP65

HALOJEN FREE

Ürün Kodu		Ölçü(cm)		Fiyat	
Opak Kapak	Şeffaf Kapak			Opak Kapak	Şeffaf Kapak
910.2130.131.000	910.2130.132.000	21 x 30 x 13	20	147,00 TL	178,00 TL
910.2635.151.000	910.2635.152.000	26 x 35 x 15	12	198,00 TL	243,00 TL
910.2635.181.000	910.2635.182.000	26 x 35 x 18	12	199,00 TL	244,00 TL
910.3040.131.000	910.3040.132.000	30 x 40 x 13	10	248,00 TL	304,00 TL
910.3040.171.000	910.3040.172.000	30 x 40 x 17	8	252,00 TL	310,00 TL
910.3040.191.000	910.3040.192.000	30 x 40 x 19	8	274,00 TL	339,00 TL
910.3040.231.000	910.3040.232.000	30 x 40 x 23	8	284,00 TL	338,00 TL
910.4050.201.000	910.4050.202.000	40 x 50 x 20	6	377,00 TL	480,00 TL
910.4060.201.000	910.4060.202.000	40 x 60 x 20	6	463,00 TL	614,00 TL
910.5070.251.000	910.5070.252.000	50 x 70 x 25	4	759,00 TL	952,00 TL



910.2130.132.000



910.2635.151.000



910.3040.232.000



910.4050.201.000

Perdeli

IP65

HALOJEN FREE

Ürün Kodu		Ölçü(cm)	Açıklama		Fiyat	
Opak Kapak	Şeffaf Kapak				Opak Kapak	Şeffaf Kapak
920.2130.131.016	920.2130.132.016	21 x 30 x 13	2 x 8 Sigorta	20	253,00 TL	284,00 TL
920.2635.151.018	920.2635.152.018	26 x 35 x 15	2 x 9 Sigorta	12	327,00 TL	372,00 TL
920.3040.131.024	920.3040.132.024	30 x 40 x 13	3 x 8 Sigorta	10	405,00 TL	460,00 TL
920.3040.171.024	920.3040.172.024	30 x 40 x 17	3 x 8 Sigorta	8	410,00 TL	465,00 TL
920.4050.201.048	920.4050.202.048	40 x 50 x 20	3 x 16 Sigorta	6	604,00 TL	707,00 TL
920.4060.201.064	920.4060.202.064	40 x 60 x 20	4 x 16 Sigorta	6	748,00 TL	898,00 TL
920.5070.251.100	920.5070.252.100	50 x 70 x 25	5 x 20 Sigorta	4	1.134,00 TL	1.326,00 TL



920.2635.151.018



920.3040.172.024



920.4050.201.048



920.4060.202.064

Perdeli + Kompakt Şalterli

IP65

HALOJEN FREE

Ürün Kodu		Ölçü(cm)	Açıklama		Fiyat	
Opak Kapak	Şeffaf Kapak				Opak Kapak	Şeffaf Kapak
922.4050.201.032	922.4050.202.032	40 x 50 x 20	2 x 16 Sigorta + 1 Kompakt Şalter	6	604,00 TL	707,00 TL
922.4060.201.048	922.4060.202.048	40x 60 x 20	3 x 16 Sigorta + 1 Kompakt Şalter	6	748,00 TL	898,00 TL
922.5070.251.080	922.5070.252.080	50 x 70 x 25	4 x 20 Sigorta + 1 Kompakt Şalter	4	1.134,00 TL	1.326,00 TL



922.4050.202.032



922.4060.201.048



922.5070.252.080

Monofaze Sayaçlı

IP65

HALOJEN FREE

Ürün Kodu		Ölçü(cm)	Açıklama		Fiyat	
Opak Kapak	Şeffaf Kapak				Opak Kapak	Şeffaf Kapak
930.2130.131.003	930.2130.132.003	21 x 30 x 13	1 Sayaç + 3 Sigorta	20	253,00 TL	284,00 TL
930.2635.151.003	930.2635.152.003	26x 35 x 15	1 Sayaç + 3 Sigorta	12	327,00 TL	372,00 TL

Monofaze Sayaç+ Dağıtımlı

IP65

HALOJEN FREE

Ürün Kodu		Ölçü(cm)	Açıklama		Fiyat	
Opak Kapak	Şeffaf Kapak				Opak Kapak	Şeffaf Kapak
931.3040.131.013	931.3040.132.013	30 x 40 x 13	1 Sayaç + 13 Sigorta	10	405,00 TL	460,00 TL
931.3040.171.013	931.3040.172.013	30 x 40 x 17	1 Sayaç + 13 Sigorta	8	410,00 TL	465,00 TL
931.4050.201.224	931.4050.202.224	40 x 50 x 20	2 Sayaç + 24 Sigorta	6	604,00 TL	707,00 TL



930.2635.151.003



931.4050.202.224

Trifaze Sayaçlı

IP65

HALOJEN FREE

Ürün Kodu		Ölçü(cm)	Açıklama	📦	Fiyat	
Opak Kapak	Şeffaf Kapak				Opak Kapak	Şeffaf Kapak
935.3040.131.010	935.3040.132.010	30 x 40 x 13	1 Sayaç + 10 Sigorta	10	405,00 TL	460,00 TL
935.3040.171.010	935.3040.172.010	30 x 40 x 17	1 Sayaç + 10 Sigorta	8	410,00 TL	465,00 TL
935.4050.201.008	935.4050.202.008	40 x 50 x 20	1 Sayaç + 8 Sigorta	6	604,00 TL	707,00 TL
935.4060.201.008	935.4060.202.008	40 x 60 x 20	1 Sayaç + 8 Sigorta	6	748,00 TL	898,00 TL
935.5070.251.010	935.5070.252.010	50 x 70 x 25	1 Sayaç + 10 Sigorta	4	1.134,00 TL	1.326,00 TL
942.5070.251.000	942.5070.252.000	50 x 70 x 25	Kompakt Şalter + Kaçak Akım + Akım Trafo	4	1.134,00 TL	1.326,00 TL



936.4050.202.008



935.4060.201.008



935.5070.252.010



942.5070.251.000

Trifaze Sayaç + Dağıtım

IP65

HALOJEN FREE

Ürün Kodu		Ölçü(cm)	Açıklama	📦	Fiyat	
Opak Kapak	Şeffaf Kapak				Opak Kapak	Şeffaf Kapak
936.4050.201.024	936.4050.202.024	40 x 50 x 20	1 Sayaç + 24 Sigorta	6	604,00 TL	707,00 TL
936.4060.201.040	936.4060.202.040	40 x 60 x 20	1 Sayaç + 40 Sigorta	6	748,00 TL	898,00 TL
936.5070.251.068	936.5070.252.068	50 x 70 x 25	1 Sayaç + 68 Sigorta	4	1.134,00 TL	1.326,00 TL



936.4050.202.024



936.4060.201.040



936.4050.252.068

Şantiye Panoları

IP65

HALOJEN FREE

Ürün Kodu		Ölçü(cm)	Açıklama		Fiyat	
Opak Kapak	Şeffaf Kapak				Opak Kapak	Şeffaf Kapak
965.4060.201.024	965.4060.202.024	40 x 60 x 20	1 Trifaze Sayaç + 24 Sigorta + 3 Priz Yeri	6	748,00 TL	898,00 TL
965.5070.251.048	965.5070.252.048	50 x 70 x 25	1 Trifaze Sayaç + 48 Sigorta + 4 Priz Yeri	4	1.134,00 TL	1.326,00 TL
965.5070.251.028	965.5070.252.028	50 x 70 x 25	1 Trifaze Sayaç + 28 Sigorta + 8 Priz Yeri	4	1.134,00 TL	1.326,00 TL
966.4050.201.032	966.4050.202.032	40 x 50 x 20	32 Sigorta + 3 Priz Yeri	6	604,00 TL	707,00 TL
966.4060.201.048	966.4060.202.048	40 x 60 x 20	48 Sigorta + 3 Priz Yeri	6	600,00 TL	725,00 TL
966.4060.201.032	966.4060.202.032	40 x 60 x 20	32 Sigorta + 6 Priz Yeri	6	748,00 TL	898,00 TL
966.5070.251.060	966.5070.252.060	50 x 70 x 25	60 Sigorta + 8 Priz Yeri	4	1.134,00 TL	1.326,00 TL



966.4050.202.032



966.4060.201.032



965.4060.202.024



965.5070.251.028

Kofra Panoları

IP65

HALOJEN FREE

Ürün Kodu		Ölçü(cm)		Fiyat	
Opak Kapak	Şeffaf Kapak			Opak Kapak	Şeffaf Kapak
923.2635.151.000	923.2635.152.000	26 x 35 x 15	12	257,00 TL	425,00 TL
923.3040.171.000	923.3040.172.000	30 x 40 x 17	8	280,00 TL	458,00 TL
923.4050.201.000	923.4050.202.000	40 x 50 x 20	6	415,00 TL	664,00 TL



923.2635.151.000



923.3040.171.000



923.4050.202.000

Harici Telefon Dağıtım
Opak Kapaklı

IP65

HALOJEN FREE

Ürün Kodu	Ölçü(cm)	Açıklama		Fiyat		
				XXX (950) Boş	XXX (951) Çatılı	XXX (952) Çatılı + Regletli
XXX.2130.131.030	21 x 30 x 13	Çatı + Regletli 30 Per	20	125,00 TL	140,00 TL	207,00 TL
XXX.2635.151.050	26 x 35 x 15	Çatı + Regletli 50 Per	12	166,00 TL	191,00 TL	304,00 TL
XXX.3040.131.100	30 x 40 x 13	Çatı + Regletli 100 Per	10	213,00 TL	263,00 TL	488,00 TL
XXX.3040.171.100	30 x 40 x 17	Çatı + Regletli 100 Per	8	199,00 TL	249,00 TL	474,00 TL
XXX.4050.201.150	40 x 50 x 20	Çatı + Regletli 150 Per	6	324,00 TL	399,00 TL	736,00 TL
XXX.4050.201.200	40 x 50 x 20	Çatı + Regletli 200 Per	6	324,00 TL	424,00 TL	874,00 TL
XXX.4050.201.300	40 x 50 x 20	Çatı + Regletli 300 Per	6	324,00 TL	474,00 TL	1.149,00 TL
XXX.4060.201.400	40 x 60 x 20	Çatı + Regletli 400 Per	6	381,00 TL	581,00 TL	1.481,00 TL
XXX.5070.251.500	50 x 70 x 25	Çatı + Regletli 500 Per	4	630,00 TL	878,00 TL	2.005,00 TL

Harici Telefon Dağıtım
Şeffaf Kapaklı

IP65

HALOJEN FREE

Ürün Kodu	Ölçü(cm)	Açıklama		Fiyat		
				XXX (950) Boş	XXX (951) Çatılı	XXX (952) Çatılı + Regletli
XXX.2130.132.030	21 x 30 x 13	Çatı + Regletli 30 Per	20	156,00 TL	171,00 TL	238,00 TL
XXX.2635.152.050	26 x 35 x 15	Çatı + Regletli 50 Per	12	212,00 TL	237,00 TL	350,00 TL
XXX.3040.132.100	30 x 40 x 13	Çatı + Regletli 100 Per	10	267,00 TL	317,00 TL	542,00 TL
XXX.3040.172.100	30 x 40 x 17	Çatı + Regletli 100 Per	8	268,00 TL	318,00 TL	543,00 TL
XXX.4050.202.150	40 x 50 x 20	Çatı + Regletli 150 Per	6	427,00 TL	502,00 TL	839,00 TL
XXX.4050.202.200	40 x 50 x 20	Çatı + Regletli 200 Per	6	427,00 TL	527,00 TL	977,00 TL
XXX.4050.202.300	40 x 50 x 20	Çatı + Regletli 300 Per	6	427,00 TL	577,00 TL	1.252,00 TL
XXX.4060.202.400	40 x 60 x 20	Çatı + Regletli 400 Per	6	531,00 TL	731,00 TL	1.631,00 TL
XXX.5070.252.500	50 x 70 x 25	Çatı + Regletli 500 Per	4	822,00 TL	1.072,00 TL	2.197,00 TL



952.2635.152.050



952.3040.131.100



952.4050.202.200



952.5070.251.500

Sulama Panoları

IP65

HALOJEN FREE

Ürün Kodu		Ölçü(cm)	Açıklama		Fiyat	
Opak Kapak	Şeffaf Kapak				Opak Kapak	Şeffaf Kapak
960.4050.201.000	960.4050.202.000	40 x 50 x 20	Voltmetre + Ampermetre + Sinyal	6	604,00 TL	707,00 TL
960.4060.201.000	960.4060.202.000	40x 60 x 20	Voltmetre + Ampermetre + Sinyal	6	748,00 TL	898,00 TL
960.5070.251.000	960.5070.252.000	50 x 70 x 25	Voltmetre + Ampermetre + Sinyal	4	1134,00 TL	1.326,00 TL



960.4050.202.000



960.4060.201.000



960.5070.252.000

Pano Aksesuarları

Ürün Kodu	Açıklama		Fiyat
740.020.000	(40 x 50 - 40 x 60 - 50 x 70) Pano Ayak	1	92,00 TL
740.030.026	26 x 35 Pano Çatı	1	49,00 TL
740.030.030	30 x 40 Pano Çatı	1	65,00 TL
740.030.045	(40 x 50 - 40 x 60) Pano Çatı	1	69,00 TL
740.030.050	50 x 70 Pano Çatı	1	94,00 TL
740.010.001	Reglet - Kesmeli	100	22,40 TL
740.011.000	Çatı - Tekli	100	5,00 TL



740.011.000



740.010.001

**M150 Plastik Gövdeli
Kablosuz Makaralar**



Ürün Kodu

Açıklama



Fiyat

150.000.04

4(1x16A) Şebeke

10

152,00 TL

150.000.04.T

4(1x16A) Şebeke + Termikli

10

180,00 TL

**M100 Metal Gövdeli Kablosuz
Makaralar - Sinyal Ledli**



Ürün Kodu

Açıklama



Fiyat

100.000.004

4(1x16A) Şebeke

10

255,00 TL

100.000.004.T

4(1x16A) Şebeke + Termikli

10



285,00 TL





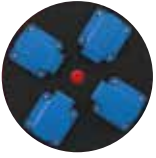
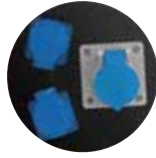

Makara Cinsi	Kablo Kesiti	3x1,5 TTR	3x2,5 TTR	3x4 TTR	4x1,5 TTR	4x2,5 TTR	4x4 TTR	5x1,5 TTR	5x2,5 TTR	5x4 TTR
M100		50	40	30	-	-	-	-	-	-
M120		100	75	60	80	65	45	75	50	40
M150		60	50	40	-	-	-	-	-	-

M120 Kablosuz Makaralar

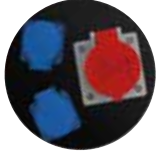
M120 Metal Gövdeli

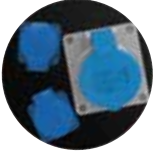
Ürün Kodu	12X.000.004	12X.000.004.T	12X.000.004E	12X.316.012	12X.416.012
Makara Göbekleri					
Açıklama	4(1x16A) Şebeke + Sinyal	4(1x16A) Şebeke + Sinyal + Termikli	4(1x16A) Pano Prizi + Sinyal	1(3x16A) CEE + 2(1x16A) Pano Prizi	1(4x16A) CEE + 2(1x16A) Pano Prizi
Makara Fiyat	330,00 TL	360,00 TL	364,00 TL	360,00 TL	370,00 TL
Tekerlekli Makara Fiyat	459,00 TL	489,00 TL	512,00 TL	480,00 TL	518,00 TL
Arabalı Makara Fiyat	527,00 TL	557,00 TL	580,00 TL	576,00 TL	586,00 TL

Ürün Kodu	12X.516.012	12X.425.012	12X.332.012	12X.432.012	12X.532.012
Makara Göbekleri					
Açıklama	1(5x16A) CEE + 2(1x16A) Pano Prizi	1(4x25A) CEE + 2(1x16A) Pano Prizi	1(3x32A) CEE + 2(1x16A) Pano Prizi	1(4x32A) CEE + 2(1x16A) Pano Prizi	1(5x32A) CEE + 2(1x16A) Pano Prizi
Makara Fiyat	376,00 TL	358,00 TL	375,00 TL	388,00 TL	396,00 TL
Tekerlekli Makara Fiyat	524,00 TL	506,00 TL	523,00 TL	536,00 TL	544,00 TL
Arabalı Makara Fiyat	592,00 TL	574,00 TL	591,00 TL	604,00 TL	612,00 TL

Makara Cinsi	Kablo Kesiti	3x1,5 TTR	3x2,5 TTR	3x4 TTR	4x1,5 TTR	4x2,5 TTR	4x4 TTR	5x1,5 TTR	5x2,5 TTR	5x4 TTR
M120		100	75	60	80	65	45	75	50	40

X = 0 Borulu Makara X = 1 Arabalı Makara X = 2 Tekerlekli Makara



120.000.004.T





122.416.012





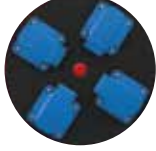

121.425.012

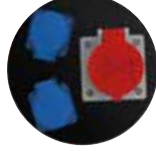
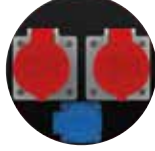
M130 Kablosuz Makaralar

M130 Metal Gövdeli

Ürün Kodu	13X.000.004	13X.416.012	13X.416.021	13X.516.012	13X.516.021
Makara Göbekleri					
Açıklama	4(1x16A) Pano Prizi + Sinyal	1(4x16A) CEE + 2(1x16A) Pano Prizi	2(4x16A) CEE + 1(1x16A) Pano Prizi	1(5x16A) CEE + 2(1x16A) Pano Prizi	2(5x16A) CEE + 1(1x16A) Pano Prizi
Makara Fiyat	469,00 TL	475,00 TL	497,00 TL	481,00 TL	509,00 TL
Tekerlekli Makara Fiyat	616,00 TL	622,00 TL	644,00 TL	628,00 TL	656,00 TL
Arabalı Makara Fiyat	684,00 TL	690,00 TL	712,00 TL	696,00 TL	712,00 TL

Ürün Kodu	13X.425.012	13X.425.021	13X.332.012	13X.432.012	13X.532.012
Makara Göbekleri					
Açıklama	1(4x25A) CEE + 2(1x16A) Pano Prizi	2(4x25A) CEE + 1(1x16A) Pano Prizi	1(3x32A) CEE + 2(1x16A) Pano Prizi	1(4x32A) CEE + 2(1x16A) Pano Prizi	1(5x32A) CEE + 2(1x16A) Pano Prizi
Makara Fiyat	463,00 TL	473,00 TL	480,00 TL	493,00 TL	501,00 TL
Tekerlekli Makara Fiyat	610,00 TL	620,00 TL	627,00 TL	640,00 TL	648,00 TL
Arabalı Makara Fiyat	678,00 TL	688,00 TL	695,00 TL	708,00 TL	716,00 TL

Makara Cinsi	Kablo Kesiti	3x1,5 TTR	3x2,5 TTR	3x4 TTR	4x1,5 TTR	4x2,5 TTR	4x4 TTR	5x1,5 TTR	5x2,5 TTR	5x4 TTR
M130		120	100	75	100	80	55	100	70	50

X = 0 Borulu Makara X = 1 Arabalı Makara X = 2 Tekerlekli Makara



130.516.012







132.532.012



131.516.021

M140 Kablosuz Makaralar

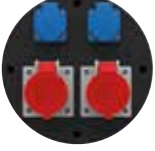
M140 Metal Gövdeli

Ürün Kodu	14X.416.022	14X.516.022	14X.425.022	14X.432.022	14X.532.022
Makara Göbekleri					
Açıklama	2(4x16A) CEE + 2(1x16A) Pano Prizi	2(5x16A) CEE + 2(1x16A) Pano Prizi	2(4x25A) CEE + 2(1x16A) Pano Prizi	2(4x32A) CEE + 2(1x16A) Pano Prizi	2(5x32A) CEE + 2(1x16A) Pano Prizi
Makara Fiyat	623,00 TL	635,00 TL	600,00 TL	659,00 TL	675,00 TL
Tekerlekli Makara Fiyat	806,00 TL	818,00 TL	872,00 TL	842,00 TL	858,00 TL
Arabalı Makara Fiyat	874,00 TL	886,00 TL	850,00 TL	910,00 TL	926,00 TL

Makara Cinsi	Kablo Kesiti	3x1,5 TTR	3x2,5 TTR	3x4 TTR	4x1,5 TTR	4x2,5 TTR	4x4 TTR	5x1,5 TTR	5x2,5 TTR	5x4 TTR
M100		50	40	30	-	-	-	-	-	-
M120		100	75	60	80	65	45	75	50	40
M130		120	100	75	100	80	55	100	70	50
M140		180	140	125	170	130	100	135	110	90
M150		60	50	40	-	-	-	-	-	-
M160		60	50	40	50	35	25	-	-	-



140.432.022



142.516.022



141.532.022



TEM

Acil Aydınlatma

Sabit ve seyyar olarak kullanılabilen ürünümüz, elektrik kesintisinde otomatik devreye girer ve fabrikalar, otoparklar, uzun koridorlar gibi geniş kullanım alanına sahiptir.



200.127.000

Çift Spotlu Acil Aydınlatma



200.127.100

Çift Spotlu Acil Aydınlatma
+ Şarj Göstergesi











100.023.000

Tek Spotlu Acil Aydınlatma

	Çalışma Voltajı	Lamba	Renk Sıcaklığı	Şarj Süresi (Saat)	Çalışma Sıcaklığı	Koruma Sınıfı	Elektrik Sınıfı	Batarya Kapasitesi	Çalışma Süresi(dk)	Ürün Boyutları
Çift Spotlu Acil Aydınlatma	220-230V AC / 50-60Hz	2x9 Led	6000 - 6500 K	24	-10°C.... +40° C	IP 40	II	12V 2.3Ah Lead Acid Battery	180	355x135x400
Tek Spotlu Acil Aydınlatma	220-230V AC / 50-60Hz	2x9 Led	6000 - 6500 K	24	-10°C.... +40° C	IP 40	II	3,6V 1800mAh NiCd Battery	120	135x100x365

Acil aydınlatma modelleri için fiyat sorunuz.

1 KV Bara Mesnet İzolatörleri

Fiçi Tip 1 KV	Ürün Kodu	Açıklama		Fiyat
	722.120.005	M5 Kör Somunlu Fiçi Tip	250	5,50 TL
	722.120.008	M8 Kör Somunlu Fiçi Tip	50	15,00 TL
	722.120.010	M10 Kör Somunlu Fiçi Tip	50	18,50 TL
722.120.005				
	722.102.005	M5 Cıvatalı Fiçi Tip	250	4,50 TL
	722.102.008	M8 Cıvatalı Fiçi Tip	50	11,50 TL
	722.102.010	M10 Cıvatalı Fiçi Tip	50	14,00 TL
722.102.005				
	722.111.005	M5 Cıvata + Kör Somunlu Fiçi Tip	250	5,00 TL
	722.111.008	M8 Cıvata + Kör Somunlu Fiçi Tip	50	13,00 TL
	722.111.010	M10 Cıvata + Kör Somunlu Fiçi Tip	50	16,00 TL
722.111.005				
Konik Tip 1 KV	Ürün Kodu	Açıklama		Fiyat
	722.220.006	M6 Kör Somunlu Konik Tip	100	7,50 TL
	722.220.008	M8 Kör Somunlu Konik Tip	50	15,00 TL
	722.220.010	M10 Kör Somunlu Konik Tip	50	18,00 TL
722.220.006				
	722.202.006	M6 Cıvatalı Konik Tip	100	5,00 TL
	722.202.008	M8 Cıvatalı Konik Tip	50	11,00 TL
	722.202.010	M10 Cıvatalı Konik Tip	50	14,00 TL
722.202.006				
	722.211.006	M6 Cıvata + Kör Somunlu Konik Tip	100	6,50 TL
	722.211.008	M8 Cıvata + Kör Somunlu Konik Tip	50	13,00 TL
	722.211.010	M10 Cıvata + Kör Somunlu Konik Tip	50	16,00 TL
722.211.006				

Tarak İzolatörler

Ürün Kodu	Açıklama		Fiyat
722.331.000	Tek Bara Taraklı - Üç Fazlı	24	19,00 TL
722.332.000	Çift Bara Taraklı - Üç Fazlı	24	35,00 TL
722.333.000	Üç Bara Taraklı - Üç Fazlı	24	22,00 TL
722.341.000	Tek Bara Taraklı - Üç Fazlı + Nötr	24	42,00 TL
722.342.000	Tek Bara Taraklı - Üç Fazlı + Nötr	24	41,00 TL

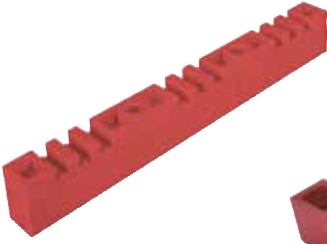

722.333.000

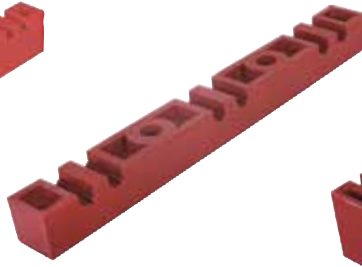

722.332.000

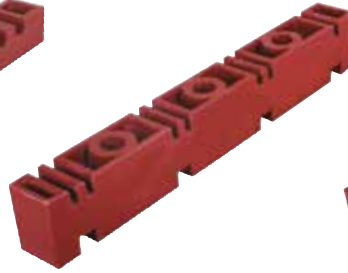

722.342.000



722.331.000

1N Serisi İzolatörler

Ürün Kodu	Açıklama		Fiyat
722.100.001	1N -B M16 Kör Somunlu	12	83,00 TL
722.100.002	1N -C M16 Kör Somunlu	12	83,00 TL
722.100.003	1N -D M16 Kör Somunlu	12	87,00 TL
722.100.004	1N -K M16 Kör Somunlu	12	85,00 TL
722.100.005	1N - 500 M16 Kör Somunlu	12	62,00 TL
722.100.008	Bara Tutucu Serfil	12	18,00 TL



722.100.003



722.100.004



722.100.005



722.100.001



722.100.002



722.100.008

Seyyar Lamba - Baladoz**Anahtarlı****Ürün Kodu**

785.000.010
785.105.010
785.110.010
785.115.010
785.120.010
785.125.010

Açıklama

Kablosuz
5m. Kablolu
10m. Kablolu
15m. Kablolu
20m. Kablolu
25m. Kablolu

Fiyat

54,00 TL
109,00 TL
143,00 TL
177,00 TL
211,00 TL
245,00 TL

Anahtarsız**Ürün Kodu**

785.000.020
785.105.020
785.110.020
785.115.020
785.120.020
785.125.020

Açıklama

Kablosuz
5m. Kablolu
10m. Kablolu
15m. Kablolu
20m. Kablolu
25m. Kablolu

Fiyat

46,00 TL
96,00 TL
130,00 TL
164,00 TL
198,00 TL
232,00 TL

Seyyar Lamba - Çanaklı Baladoz**Anahtarlı****Ürün Kodu**

786.000.010
786.107.010

Açıklama

Kablosuz
7.5m. Kablolu

Fiyat

124,00 TL
199,00 TL

Anahtarsız**Ürün Kodu**

786.000.020
786.107.020

Açıklama

Kablosuz
7.5m. Kablolu

Fiyat

112,00 TL
177,00 TL

Bant Armatür Soketleri



787.100.100
Tekli Klasik
9,00 TL / Tk.



787.100.200
Çiftli Klasik
13,00 TL / Tk.



787.300.000
Starter Yuvası
4,00 TL / Tk.



Fiyat Sorunuz.

24V 100W

Kablolar



725.315.113
Çift Topraklı Fişli Kablo
3G 1,5 H0VV-F 3m.



725.325.113
Çift Topraklı Fişli Kablo
3G 2,5 H0VV-F 3m.



725.310.212
Güç Kablosu
3G 1 H0VV-F 1,8m.



725.315.123
İngiliz Fişli Kablo
3G 1,5 H0VV-F 3m.

Kablolar için fiyat sorunuz.

Kablo Bağı



Ürün Kodu

Açıklama



Fiyat

736.230.210
736.230.214
736.230.220
736.230.315
736.230.320
736.230.325
736.230.330
736.230.337
736.230.420
736.230.425
736.230.430
736.230.435
736.230.440
736.230.845
722.230.855
722.230.976
722.230.994

2.5 x 100
2.5 x 140
2.5 x 200
3.6 x 150
3.6 x 205
3.6 x 250
3.6 x 300
3.6 x 370
4.8 x 200
4.8 x 250
4.8 x 300
4.8 x 350
4.8 x 400
8 x 450
8 x 550
9 x 762
9 x 940

100
100
100
100
100
100
100
100
100
100
100
100
100
100
100
100
100
100

0,091 TL
0,135 TL
0,197 TL
0,216 TL
0,280 TL
0,341 TL
0,413 TL
0,537 TL
0,403 TL
0,484 TL
0,587 TL
0,662 TL
0,759 TL
1,463 TL
1,937 TL
4,202 TL
4,944 TL



İskan ERDOĞMUŞ
Satış Koordinatörü

Bölgesi

İstanbul, Bursa, Muğla, İzmir, Aydın, Denizli, Manisa,
Trakya Bölgesi, Karaköy, Perpa

Telefon

0532 417 31 86

E-Posta

iskanerdogmus@temteknik.com

Aydın KAPLAN
Satış Sorumlusu

İstanbul Anadolu Yakası, Doğu Anadolu Bölgesi,
Güneydoğu Anadolu Bölgesi, Karadeniz Bölgesi,
Silivri, İkitelli

0533 694 10 19

aydin@temteknik.com

Ersoy ERDOĞAN
Satış Sorumlusu

Kocaeli, Sakarya, Ankara, Kırıkkale, Konya, Aksaray, Bolu,
Düzce, Nevşehir, Afyon, Yalova, Kırşehir, Zonguldak, Karabük,
Bartın

0535 107 70 65

ersoy@temteknik.com

Murat ÇİFTÇİ
Satış Sorumlusu

İstanbul Avrupa Yakası, Çerkezköy, Çorlu, Tekirdağ,
Malkara, Keşan, Çanakkale, Balıkesir, Bilecik, Eskişehir,
Kütahya, Uşak, Isparta, Burdur, Antalya

0531 381 04 38

muratciftci@temteknik.com

TEM®

TEM TEKNİK ELEKTRİK MALZEMELERİ SANAYİ VE TİCARET ANONİM ŞİRKETİ



Selimpaşa Ortaköy Sanayi Bölgesi, İltar Bulvarı, Mor Menekşe Sok, No:5 34590
SİLİVRİ / İSTANBUL / TÜRKİYE



+90 212 485 19 00



+90 212 485 15 33



www.temteknik.com



info@temteknik.com